

Tecnico — 2018
*Tavolo, Terra,
Sospensione, Soffitto,
Parete, Esterno.*

FOSCARINI

Tecnico — 2018
Europe
Valid from 1st January 2018

FOSCARINI



Index

Tavolo →



Anisha
→ p. 014



Behive
→ p. 015



Binic
→ p. 016



Birdie
→ p. 017



Buds 1 - 2 - 3
→ p. 018



Caboche
→ p. 019



Doll
→ p. 020



Esa
→ p. 021



Filo
→ p. 022



Gem
→ p. 023



Gregg
→ p. 024



Kurage
→ p. 025



Lumiere
+ Lumiere 25th
→ p. 026-028



Lumiere XXL + XXS
→ p. 029



Magneto
→ p. 030



Plass media
→ p. 031



Poly Gregg
→ p. 032

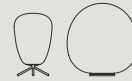

Rituals + XL
→ p. 034-35



Satellight
→ p. 033



Tress
→ p. 036



Twiggy XL
→ p. 037



Uto
→ p. 038



Yoko
→ p. 039

Index

Terra →



Aplomb
→ p. 042



Birdie
→ p. 043



Caboche
→ p. 044



Dolmen
→ p. 045



Filo
→ p. 046



Giga-Lite
→ p. 047



Gregg
→ p. 048



Havana
→ p. 049



Lightwing
→ p. 050



Lumiere XXL
→ p. 051



Magneto
→ p. 052



Mite
→ p. 053



Orbital
→ p. 054



Tress
→ p. 055



Tress Stilo
→ p. 056

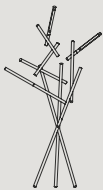

Tuareg
→ p. 057

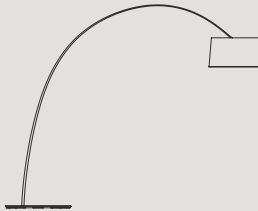

Twice as Twiggy
→ p. 058

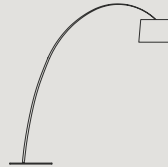

Twiggy
→ p. 059



Twiggy lettura
→ p. 060



Allegretto
→ p. 064



Allegro
→ p. 065

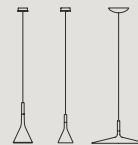

Aplomb
+ mini + large
→ p. 066-068

Sospensione →

Index



Arumi
→ p. 069



Behive
→ p. 070

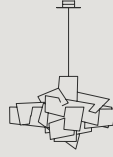

Big Bang + L + XL
→ p. 072-073



Birdie
→ p. 071



Buds
→ p. 074

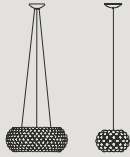

Caboche grande
+ media + piccola
→ p. 076-078



Caigo
→ p. 079



Chouchin + mini
+ reverse
→ p. 080-083

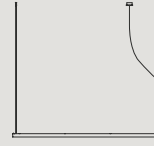

Dolmen
→ p. 084



Gem
→ p. 085



Giga-Lite
→ p. 088



Gregg
→ p. 086



Havana
→ p. 089

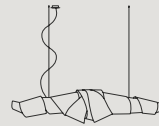

Jamaica
→ p. 090



Le Soleil
→ p. 091

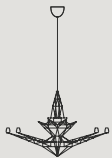

Lightweight
→ p. 092



Maki
→ p. 093



O-space
→ p. 094



Planet
→ p. 095



Plass grande
+ media
→ p. 096-097

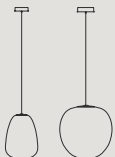

Rituals + Rituals XL
→ p. 098



Satellight
→ p. 100

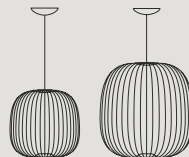

Spokes
+ Spokes 2 large
→ p. 102



Supernova
→ p. 101



Tartan
→ p. 104

Index



Tite
→ p. 105

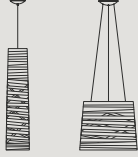

Tress + grande
→ p. 106-108



Tress stilo
→ p. 109

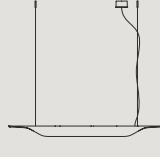

Troag
→ p. 110



Tropico
→ p. 111

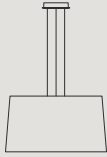

Twice as Twiggy
→ p. 112



Twiggy
→ p. 113



Uto
→ p. 114



Soffitto → Bahia + Bahia mini
→ p. 128

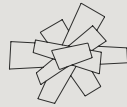

Big Bang
→ p. 129

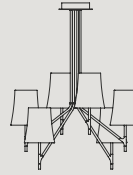

Birdie 3 - 6 - 9
→ p. 130



Blob S
→ p. 132



Caboche
→ p. 133



Circus
→ p. 134



Ellepi
→ p. 135



Folio
→ p. 136



Gregg
→ p. 137



Lumiere XXL + XXS
→ p. 138

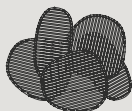

Nuage
→ p. 139



Rituals
→ p. 140



Tivu
→ p. 141



Twiggy
→ p. 142

Index

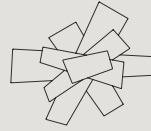
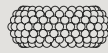
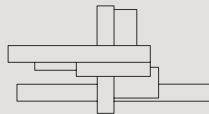
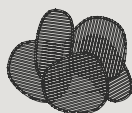
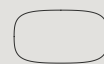
Parete →Aplomb
→ p. 146Bahia + Bahia mini
→ p. 147Big Bang
→ p. 148Birdie
→ p. 149Bit
→ p. 150Blob S
→ p. 151Caboche
→ p. 152Circus
→ p. 153Double
→ p. 154Ellepi
→ p. 155Fields
→ p. 156Filo
→ p. 157Folio
→ p. 158Gregg
→ p. 159Havana
→ p. 160Innerlight
→ p. 161Kite
→ p. 162Lake
→ p. 163Le Soleil
→ p. 164Lumiere XXL + XXS
→ p. 165Nuage
→ p. 166Rituals
→ p. 167Satellight
→ p. 168Tivu
→ p. 169

Index



Tress
→ p. 170



Tutù
→ p. 171

Esterno →



Gregg outdoor
terra
→ p. 174



Havana outdoor
terra
→ p. 175



Solar outdoor
→ p. 176



Gregg outdoor
sospensione
→ p. 177



Havana outdoor
sospensione
→ p. 178



Uto
sospensione
→ p. 179

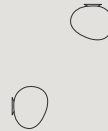

Gregg MIDI
parete / soffitto
→ p. 180



Rosone
tondo
→ p. 116



Rosone
lineare L 90
→ p. 116

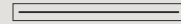

Rosone
lineare L 135
→ p. 117

Accessori →

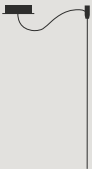

Kit
decentramento
→ p. 124



Packing
→ p. 182

LED + DIMMING
→ p. 189



INFO
→ p. 190

Legenda



LED

It marks the models with integrated LED included in the lamp, which is the result of Foscarini designing and engineering.



ENEC

The label ENEC (Electrical Certification concerning European Standard) is a voluntary label granted by third organizations. It certifies that a product complies with the EN 60598 standards and has been designed and manufactured by companies with an approved UNI EN ISO 9001 quality control system.



Declares that the manufacturer produces light fittings which comply with the requirements of the EN 60598.



Classe I

Class I° luminaire: it's necessary to connect the device to the yellow/green protective conductor (earthing).



Classe II

Light fittings whose safety is guaranteed only by the double and/or reinforced insulation of all parts, with no earth.

IP

IP Protection Degree

/P20: protected against the penetration of solid objects greater than 12 mm and non protected against liquids.
IP44: protected against the penetration of solid objects greater than 1 mm and protected against splashing water.
IP65: dust-tight and protected against water jets.

Energy efficiency classes

The energy efficiency classes for light appliances set out by EU regulation no. 874/2012 are calculated on the basis of the Energy Efficiency Index (EEI) and range between A++ (maximum efficiency) and E (minimum efficiency).

Note:

Dimmer

The dimmer could cause flickering of the light in case of use of a bulb with a lower wattage than the minimum indicated. It is not possible to guarantee the proper functioning of the dimmer with LED retrofit bulbs or compact Fluo bulbs with integrated power supply.

Special colours:

it shows the possibility to order the lamps in a different color than the standard one (generally in the lampshade); minimum quantity, price and lead time on request.

Azienda certificata

UNI EN ISO 9001

UNI EN ISO 14001



CSQ - IQNET

The CSQ-IQNET label is valid all over the world. It certifies that Foscarini runs a quality management system which complies with the UNI EN ISO 9001:2008 standard, to guarantee a high quality level for what concerns project, development, production and distribution of its products.



CSQ ECO

This label is valid all over the world. It certifies that Foscarini runs an environmental management system which complies with the UNI EN ISO 14001:2004 standard in order to guarantee company's commitment to continual improvement of its environmental performances.

Excerpt from sales conditions

1. Our prices are net ex works.
2. The prices include: carton packaging, transformers for low tensions. Prices do not include bulbs, if not differently stated.
3. The prices here contained refer to materials complying with the technical standards of the market this price list is meant for. Any request for material complying with other standards shall be quoted separately.
4. Goods are carefully inspected and accurately packed before shipment, Foscarini Spa therefore declines any liability for transport damages.
5. The goods are dispatched at the buyer's risk, even if sent free domicile.
6. Claims must be notified by registered mail addressed to our head offices within 3 days from receipt of the goods.
7. Any litigation falls within cognisance of Venice Italy Law-Court.
8. Dimensions and colours indicated have a tolerance due to the characteristic handwork of materials.
9. This price list can be subject to alteration without any notice.
10. Products images and configurations may vary from price book, catalogues and website from the actual merchandise, including but not limited to cords, cables, color, price, dimension, descriptions, details, dimmer.
11. Foscarini reserves the property of the goods until full payment of the same.
12. Prices are expressed in Euro.
13. This price list replaces any previous one.

iFoscarini app



iFoscarini an app designed for all design enthusiasts who wish to customise their surroundings with the unmistakable personality of Foscarini models.

With captivating and emotional graphics and extremely user-friendly it allows users to insert lamps in rooms and settings which are caught on camera each time or picked from an archive of pictures. Available on the Apple Store and Play Store the iFoscarini app is a very effective tool that is extremely simple to use.

Social media

Foscarini is present on all the main social networks with systems and languages suited to each individual channel and type of user:

- **Facebook** to create and maintain public relations, communicate news and projects, share news, images and films;
- **Instagram** to view projects and stimulate users to create images with Foscarini models.
- **Twitter** publicise events, initiatives, news and links in brief, high impact messages;
- **Pinterest** to share images of Foscarini models and initiatives, subdividing them into theme boards;
- **LinkedIn** to create and maintain relationships with sector operators and share professional contents



foscarini.com



Packed with content, the www.foscarini.com website keeps you up-to-date on our products, events and cultural initiatives at all times. The Video Stories section gives you the chance to find out about the concept and development of some of the most important Foscarini products. Information on the company, detailed technical data sheets for all models, assembly instructions, 2D and 3D designs as well as photometric curves can all be downloaded.

myFoscarini



With the same spirit that provides new ideas in lighting design, Foscarini creates its own more efficient programs for customer and partner communication, for instance, **myFoscarini**, a proprietary it platform, an absolutely innovative, highly flexible and transparent tool providing customers with complete information and full range of functions. With just a few clicks in my foscarini you can:

- check the availability of lamps and the shipping date
- Enter your orders, reserving lamps directly from Foscarini's central system

- track your order status
 - consult sale conditions;
 - download admin documents such as transport documents and invoices;
 - prepare a quotation;
 - download: images, logos, PDF and excel price lists assembly instructions, certifications and energy labels. And all this 7 days a week, 24 hours a day.
- If you haven't registered yet request your password from Foscarini Customer Care.



Tavolo, *Table*014 **Anisha**015 **Behive**016 **Binic**017 **Birdie**018 **Buds**019 **Caboche**020 **Doll**021 **Esa**022 **Filo**023 **Gem**024 **Gregg**025 **Kurage**026 **Lumiere**028 **Lumiere 25th**029 **Lumiere****XXL + XXS**030 **Magneto**031 **Plass media**032 **Poly Gregg**034 **Rituals**033 **Satellight**036 **Tress**037 **Twiggy XL**038 **Uto**039 **Yoko**

Anisha

Lievore Altherr Molina,
2011



	energy cl.	colours	code	vat excluded
<i>Anisha grande</i>	A ⁺	bianco	213001R1 10	352,94
<i>Anisha piccola</i>	A ⁺	bianco	2130012R1 10	281,51

Injection moulded ABS

Anisha grande

LED included
Power LED 4,5W 3000° K
400 lm CRI>80 88 lm/W
Integrated touch dimmer

Anisha piccola

LED included
Power LED 3,4W 3000° K
300 lm CRI>80 88 lm/W
Integrated touch dimmer

Colours: bianco



Weight:

Anisha grande
net kg 0,70

Anisha piccola
net kg 0,40

With personalized packaging



Tecnico — 2018

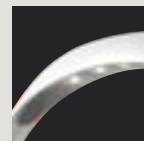
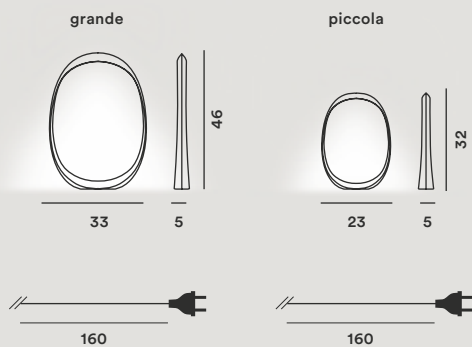

Behive

Werner Aisslinger, 2011



Batch-dyed ABS,
polycarbonate and coated
metal

Halo or LED retrofit
1x150W E27
Dimmer included

☐ CE ⚡ IP 20

	energy cl.	colours	code	vat excluded
<i>Behive</i>	A ⁺ , A	bianco	203001 10	420,17
Spare parts:				
<i>Lampshade Behive</i>		bianco	203S00 10	191,60
<i>Protection glass</i>			203V01/1	49,58

Colours: bianco



Weight:
net kg 3,70

Halo, LED retrofit
light bulbs not included
→ specifications p. 190

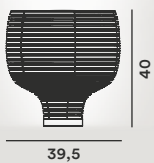

collection →



p. 070

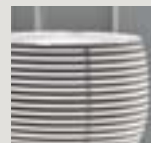

Binic

Ionna Vautrin, 2010



	energy cl.	colours	code	vat excluded
<i>Binic</i>	A+, A	bianco	20000110	121,85
		antracite	20000127	
		verde acqua	20000142	
		giallo	20000155	
		rosa	20000161	
		blu	20000187	

Batch-dyed ABS and polycarbonate

LED retrofit or Fluo
1x12W E 14

With personalized packaging



Colours: bianco, antracite, Weight:
verde acqua, giallo, net kg 0,60
rosa, blu



Fluo, LED retrofit light
bulbs not included
→ specifications p. 190

Tecnico — 2018

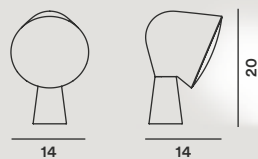

Birdie

Ludovica + Roberto
Palomba, 2011



Polycarbonate, varnished
steel and metal

Birdie grande on/off
LED retrofit or Fluo
1x25W E27
Halo 1x150W E27

Birdie grande
with integrated touch dimmer
Halo or dimmable LED
retrofit 1x150 E27

Birdie piccola on/off
LED retrofit or Fluo
1x20W E27
Halo 1x70W E27

Birdie piccola
with integrated touch dimmer
Dimmable LED retrofit or
Halo 1x70W E27

CE IP 20

	energy cl.	colours	code	vat excluded
<i>Birdie grande on/off</i>	A+, A	bianco	221001S 10	277,31
		grigio	221001S 25	
		arancio	221001S 53	
		amaranto	221001S 65	
<i>Birdie grande</i> with touch dimmer	A+, A	bianco	221001 10	336,14
		grigio	221001 25	
		arancio	221001 53	
		amaranto	221001 65	
<i>Birdie piccola on/off</i>	A+, A	bianco	2210012 10	235,30
		grigio	2210012 25	
		arancio	2210012 53	
		amaranto	2210012 65	
<i>Birdie piccola</i> with touch dimmer	A+, A	bianco	2210012DM 10	287,40
		grigio	2210012DM 25	
		arancio	2210012DM 53	
		amaranto	2210012DM 65	
Spare parts:				
<i>Lampshade Birdie grande</i>		bianco	221S00 10	65,55
		grigio	221S00 25	
		arancio	221S00 53	
		amaranto	221S00 65	
<i>Lampshade Birdie piccola</i>		bianco	221S002 10	46,22
		grigio	221S002 25	
		arancio	221S002 53	
		amaranto	221S002 65	

Colours: bianco, grigio,
arancio, amaranto

Weight:
Birdie grande
net kg 4,00

Halo, Fluo, LED retrofit
light bulbs not included
→ specifications p. 190



Birdie piccola
net kg 2,00

Special colours
on request

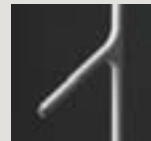
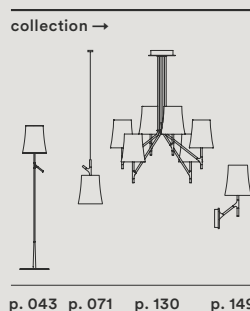
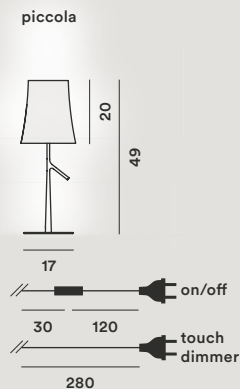
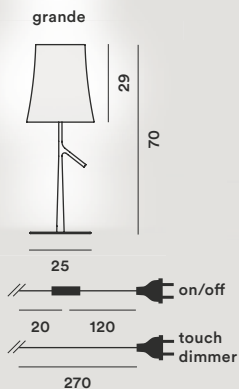

Buds

Rodolfo Dordoni, 2016



Blown glass and PMMA

LED retrofit or Fluo
max 1x23W E27
Ø 9-12 cm

Recommended white globe
bulb
Ø 12 cm for Buds 1-2
Ø 9 cm for Buds 3



	energy cl.	colours	code	vat excluded
Buds 1	A+, A	bianco caldo	278011 12	705,88
		marrone	278011 54	
Buds 2	A+, A	bianco caldo	278012 12	739,50
		grigio	278012 24	
Buds 3	A+, A	bianco caldo	278013 12	668,07
		verde	278013 40	
Spare parts:				
Glass Buds 1		bianco caldo	278S001 12	334,45
		marrone	278S001 54	
Glass Buds 2		bianco caldo	278S002 12	368,07
		grigio	278S002 24	
Glass Buds 3		bianco caldo	278S003 12	304,20
		verde	278S003 40	

Colours:
Buds 1 bianco caldo,
marrone.
Buds 2 bianco caldo,
grigio.
Buds 3 bianco caldo,
verde bambù



Weight:
Buds 1
net kg 4,90
Buds 2
net kg 6,20
Buds 3
net kg 4,20

Fluo, LED retrofit light
bulbs not included
→ specifications p. 190

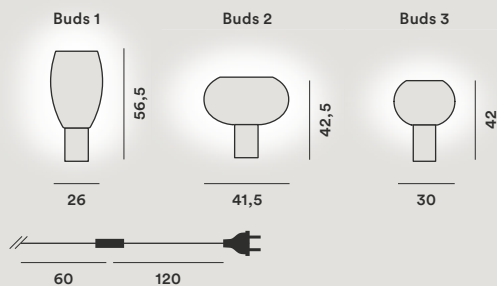

collection →



Caboche

Patricia Urquiola con
Elia Gerotto, 2005



	energy cl.	colours	code	vat excluded
Caboche	A ⁺ , A, C	trasparente	138012 16	504,20
		giallo oro	138012 52	
Spare parts:				
Kit 10 spheres Caboche		trasparente	138KIT 10SF16	39,50
		giallo oro	138KIT 10SF52	
Kit 10 prongs 3 sphere Caboche tavolo			138KIT 10P3	24,37
Kit 10 prongs 4 sphere Caboche tavolo			138KIT 10P4	24,37
Kit 3+3 prongs 3-4 sphere Caboche tavolo			138KIT2-R2	17,65
Glass Caboche tavolo			138V012/1	42,02

PMMA, blown glass and coated aluminium

Halo or LED retrofit
1x48W G9
Dimmer included
minimum Halo bulb output
40W

☐ CE IP 20

Colours: trasparente,
giallo oro

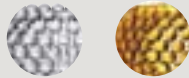

Weight:
net kg 5,30

Halo, LED retrofit
light bulbs not included
→ specifications p. 190

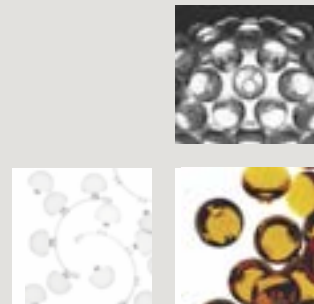
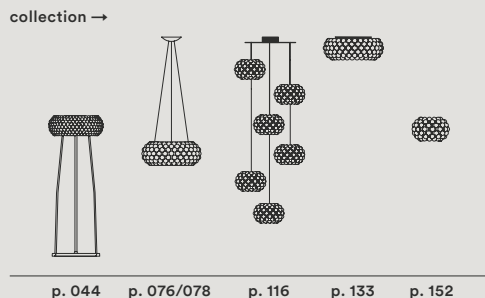
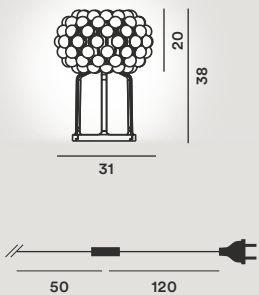

020 Tavolo, Table

Doll

Ionna Vautrin, 2012



	energy cl.	colours	code	vat excluded
<i>Doll</i>	A+, A	grigio*	24500125	134,45
		verde*	24500140	
		avorio*	24500150	
		rosso*	24500163	

Spare parts:

<i>Glass Doll</i>		245S0010	63,03
-------------------	--	----------	-------

* Limited stock available

Blown glass, batch-dyed
ABS and polycarbonate

LED retrofit or Fluo
1x12W E14

With personalized packaging

☐ CE IP 20

Colours: grigio*, verde*,
avorio*, rosso*

* Limited stock available



Weight:
net kg 0,70

Fluo, LED retrofit light
bulbs not included
→ specifications p. 190

Tecnico — 2018

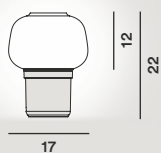

Esa

Lievore Altherr Molina,
1996



Blown glass and polished
aluminium

Esa grande
LED retrofit or Fluo
1x20W E27
Halo 1x77W E27

Esa piccola
Halo or LED retrofit
1x40W G9
Dimmer included
minimum Halo bulb output
10W

☐ CE IP 20

	energy cl.	colours	code	vat excluded
<i>Esa grande</i>	A ⁺ , A	bianco	075001-R2 11	584,88
<i>Esa piccola</i>	A ⁺ , A, C	bianco	0750012 11	329,41

Spare parts:

<i>Glass Esa grande</i>	bianco	075S00 11	267,23
<i>Glass Esa piccola</i>	bianco	075S002 11	146,22

Colours: bianco



Special colours
on request

Weight:
Esa grande
net kg 3,20

Esa piccola
net kg 2,30

Halo, Fluo, LED retrofit
light bulbs not included
→ specifications p. 190

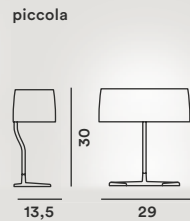
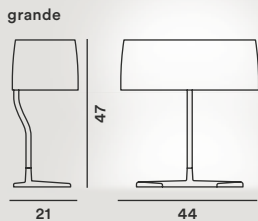

022 Tavolo, Table

Filo

Andrea Anastasio, 2017



Porcelain, blown glass and coated metal

LED retrofit included
4W G9 3000°K
400 lm CRI>80



	energy cl.	colours	code	vat excluded
<i>Filo</i>	A ⁺	amethyst queen	289001-01	PREZZO 302,52
		eastern coral	289001-02	
		koh-i-noor	289001-03	
		teodora	289001-04	
		southern talisman	289001-05	
		ruby jaypure	289001-06	
		izmir	289001-07	
		emerald king	289001-08	

Colours:

Amethyst Queen

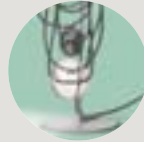

Eastern Coral



Weight:
net kg 4,20

Koh-i-noor



Teodora

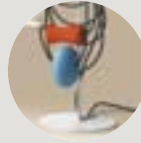

Southern Talisman

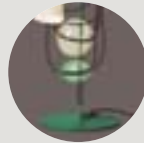

Ruby Jaypure

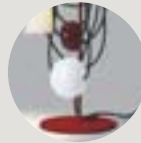

Izmir

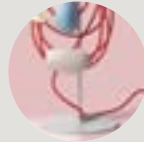

Emerald King

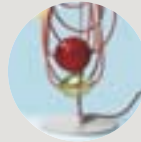

Tecnico — 2018

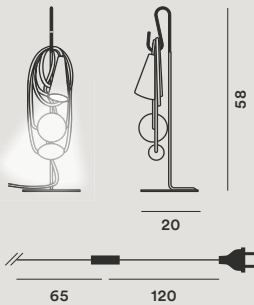

collection →

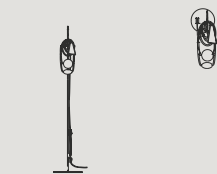

p. 046

p. 157



Gem

Ludovica + Roberto

Palomba, 2017



Blown acid-etched glass
with reliefs, gold-plating
satin aluminium.

LED retrofit
dimnable 1x25W
Halo 1x150W E27
Dimmer included

☐ CE IP 20

	energy cl.	colours	code	vat excluded	
Gem	A ⁺ , A	bianco	274001-10	PREZZO	655,47
Spare parts:					
Glass Gem		bianco	274S00-10	PREZZO	180,80

Colours: bianco



Weight:
net kg 6,00

Halo, LED retrofit
light bulbs
not included
→ specifications p. 190

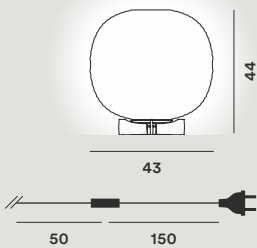

collection →



p. 85

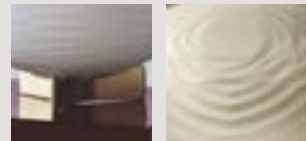

Gregg

Ludovica + Roberto
Palomba, 2007



	energy cl.	colours	code	vat excluded
<i>Gregg grande on/off</i>	A+, A	bianco	168001S 10	506,73
<i>Gregg grande w. dimmer</i>	A+, A		1680011 10	526,05
<i>Gregg media on/off</i>	A+, A	bianco	168001S 10	300,00
<i>Gregg media w. dimmer</i>	A+, A		1680011 10	319,33
<i>Gregg midi on/off</i>	A	bianco	1680013-10	252,10
<i>Gregg piccola on/off</i>	A+, A, C	bianco	1680012S 10	145,38
<i>Gregg piccola w. dimmer</i>	A+, A, C		1680012 10	174,79

Spare parts:

<i>Glass Gregg grande</i>	bianco	168S001 10	317,65
<i>Glass Gregg media</i>	bianco	168S00 10	171,43
<i>Glass Gregg midi</i>	bianco	168RV003-10	89,29
<i>Glass Gregg piccola</i>	bianco	168S00210	58,82

Blown acid-etched glass and coated metal

Gregg grande on/off
LED retrofit or Fluo
1x25W E27
Halo 1x205W E27

Gregg grande with dimmer
Halo or dimmable LED
retrofit 1x205W E27

Gregg media on/off
LED retrofit or Fluo
1x20W E27
Halo 1x150W E27

Gregg media with dimmer
Halo or dimmable LED
retrofit 1x150W E27

Gregg midi on/off
LED included COB 8,5W
2700° K 700 lm CRI>90

Gregg piccola on/off
LED retrofit or Halo 1x25W G9

Gregg piccola with dimmer
LED retrofit o Halo 1x25W G9
minimum Halo bulb output
10W

Colours: bianco



Weight:
Gregg grande
net kg 6,80

Gregg media
net kg 3,30

Gregg midi
net kg 1,60

Gregg piccola
net kg 0,60

Halo, Fluo, LED retrofit
light bulbs not included
→ specifications p. 190

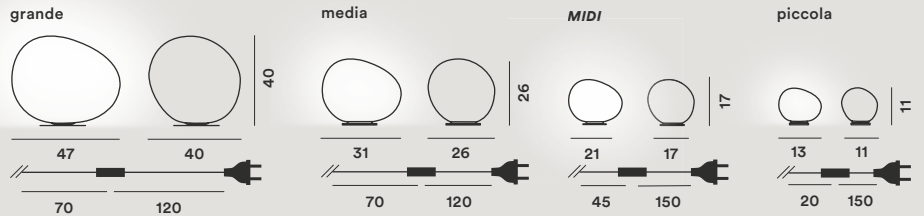

collection →

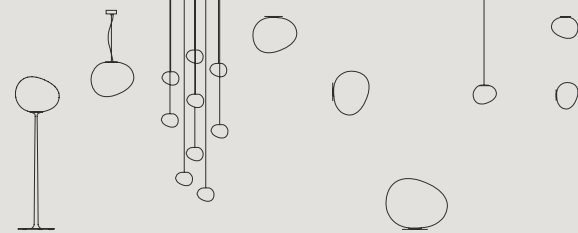

p. 048 p. 086 p. 116 p. 137 p. 159 p. 174 p. 177 p. 180



025

Kurage

Nichetto + Nendo, 2015



Washi paper and ashwood

LED retrofit or Fluo
1x12W E27

CE IP 20

	energy cl.	colours	code	vat excluded
<i>Kurage</i>	A+, A	bianco	258001 10	462,18
Spare parts:				
<i>Lampshade Kurage</i>		bianco	258S00 10	168,07

Colours: bianco



Weight:
net kg 0,70

Fluo, LED retrofit light
bulbs not included
→ specifications p. 190

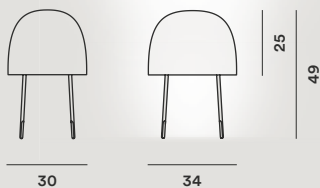

Lumiere grande

Rodolfo Dordoni, 1990



Blown glass and polished aluminium or black chrome

Lumiere grande on/off
Halo or LED retrofit
2x48W G9

Lumiere grande with dimmer
Halo or LED retrofit
2x48W G9
minimum Halo bulb output
40W



	energy cl.	colours	code	vat excluded
<i>Lumiere grande on/off</i>	A+, A, C	alluminio/bianco	026001R2 11	428,57
		all./bianco caldo	026001R2 12	487,40
		all./turchese	026001R2 32	
		all./ciliegia	026001R2 62	
<i>Lumiere grande on/off</i>	A+, A, C	cromo nero/bianco	026011R2 11	428,57
		c. nero/bianco caldo	026011R2 12	487,40
		c. nero/turchese	026011R2 32	
		c. nero/ciliegia	026011R2 62	
<i>Lumiere grande on/off</i>	A+, A, C	champagne/bianco	026021R2 11	428,57
		cham./bianco caldo	026021R2 12	487,40
		cham./turchese	026021R2 32	
		cham./ciliegia	026021R2 62	
<i>Lumiere grande with dimmer</i>	A+, A, C	alluminio/bianco	026001R2 11 D	457,98
		all./bianco caldo	026001R2 12 D	516,81
		all./turchese	026001R2 32 D	
		all./ciliegia	026001R2 62 D	
<i>Lumiere grande with dimmer</i>	A+, A, C	cromo nero/bianco	026011R2 11 D	457,98
		c. nero/bianco caldo	026011R2 12 D	516,81
		c. nero/turchese	026011R2 32 D	
		c. nero/ciliegia	026011R2 62 D	
<i>Lumiere grande with dimmer</i>	A+, A, C	champagne/bianco	026021R2 11 D	457,98
		cham./bianco caldo	026021R2 12 D	516,81
		cham./turchese	026021R2 32 D	
		cham./ciliegia	026021R2 62 D	
Spare parts:				
<i>Glass Lumiere grande</i>		bianco	026S00 11	180,67
		bianco caldo	026S00 12	239,50
		turchese	026S00 32	
		ciliegia	026S00 62	

Glass colours:
bianco, bianco caldo,
ciliegia, turchese

Weight:
net kg 2,40

Halo, LED retrofit
light bulbs not included
→ specifications p. 190

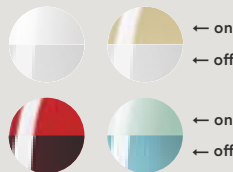

Frame colours:
alluminio, cromo nero,
champagne



collection →

Special colours
on request



p. 028

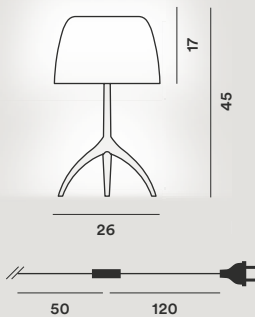

Lumiere piccola

Rodolfo Dordoni, 1990



Blown glass and polished
aluminium or black chrome

Lumiere piccola on/off
Halo or LED Retrofit
1x42W G9

*Lumiere piccola
with dimmer*
Halo or LED Retrofit
1x42W G9
minimum Halo bulb output
40W



	energy cl.	colours	code	vat excluded
<i>Lumiere piccola on/off</i>	A ⁺ , A, C	alluminio/bianco	0260012R2 11	294,12
		all./bianco caldo	0260012R2 12	348,74
		all./turchese	0260012R2 32	
		all./ciliegia	0260012R2 62	
<i>Lumiere piccola on/off</i>	A ⁺ , A, C	cromo nero/bianco	0260112R2 11	294,12
		c. nero/bianco caldo	0260112R2 12	348,74
		c. nero/turchese	0260112R2 32	
		c. nero/ciliegia	0260112R2 62	
<i>Lumiere piccola on/off</i>	A ⁺ , A, C	champagne/bianco	0260212R2 11	294,12
		cham./bianco caldo	0260212R2 12	348,74
		cham./turchese	0260212R2 32	
		cham./ciliegia	0260212R2 62	
<i>Lumiere piccola with dimmer</i>	A ⁺ , A, C	alluminio/bianco	0260012R2 11D	323,53
		all./bianco caldo	0260012R2 12D	378,15
		all./turchese	0260012R2 32D	
		all./ciliegia	0260012R2 62D	
<i>Lumiere piccola with dimmer</i>	A ⁺ , A, C	cromo nero/bianco	0260112R2 11D	323,53
		c. nero/bianco caldo	0260112R2 12D	378,15
		c. nero/turchese	0260112R2 32D	
		c. nero/ciliegia	0260112R2 62D	
<i>Lumiere piccola with dimmer</i>	A ⁺ , A, C	champagne/bianco	0260212R2 11D	323,53
		cham./bianco caldo	0260212R2 12D	378,15
		cham./turchese	0260212R2 32D	
		cham./ciliegia	0260212R2 62D	
Spare parts:				
<i>Glass Lumiere piccola</i>		bianco	026S002R 11	102,52
		bianco caldo	026S002R 12	157,14
		turchese	026S002R 32	
		ciliegia	026S002R 62	

Glass colours:
bianco, bianco caldo,
ciliegia, turchese

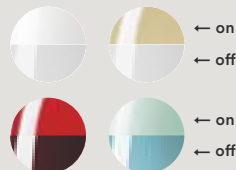

Weight:
net kg 1,10

Halo, LED retrofit
light bulbs not included
→ specifications p. 190

Frame colours:
alluminio, cromo nero,
champagne



collection →

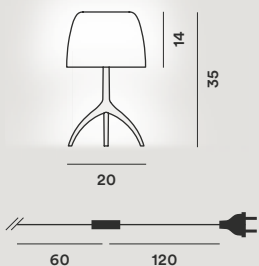

Special colours
on request



Lumiere 25th

Rodolfo Dordoni,
1990/2015



Blown mirrored glass and polished or varnished aluminium

Lumiere 25th grande on/off
Halo or LED Retrofit
2x48W G9

Lumiere 25th grande with dimmer
Halo or LED Retrofit
2x48W G9
minimum Halo bulb output
40W

Lumiere 25th piccola on/off
Halo or LED Retrofit
1x42W G9

Lumiere 25th piccola with dimmer
Halo or LED retrofit 1x42W G9
minimum Halo bulb output
40W



	energy cl.	colours	code	vat excluded
<i>Lumiere 25th grande</i>	A ⁺ , A, C	alluminio/25 th	026001R2 30	647,06
		cromo nero/25 th	026011R2 30	
		champagne/25 th	026021R2 30	
<i>Lumiere 25th grande with dimmer</i>	A ⁺ , A, C	alluminio/25 th	026001R2 30 D	676,47
		cromo nero/25 th	026011R2 30 D	
		champagne/25 th	026021R2 30 D	
<i>Lumiere 25th piccola</i>	A ⁺ , A, C	alluminio/25 th	0260012R2 30	491,60
		cromo nero/25 th	0260112R2 30	
		champagne/25 th	0260212R2 30	
<i>Lumiere 25th piccola with dimmer</i>	A ⁺ , A, C	alluminio/25 th	0260012R2 30D	521,01
		cromo nero/25 th	0260112R2 30D	
		champagne/25 th	0260212R2 30D	

Spare parts:

<i>glass Lumiere 25th grande</i>	026S00 30	399,16
<i>glass Lumiere 25th piccola</i>	026S002R 30	300,00

Glass colours:
specchio trasparente



Weight:
Lumiere 25th grande
net kg 2,40

Lumiere 25th piccola
net kg 1,10

Halo, LED retrofit
light bulbs not included
→ specifications p. 190

Frame colours:
alluminio, cromo nero,
champagne

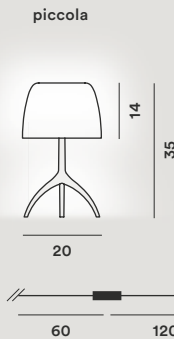
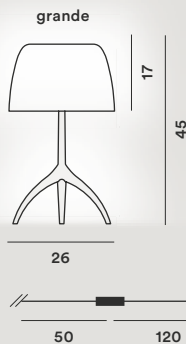

collection →

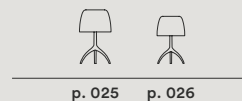

Lumiere XXL - XXS

Rodolfo Dordoni, 2009



Blown glass and lacquered aluminium

Lumiere XXL

Halo or LED retrofit 4x33W G9
Dimmer included
minimum Halo bulb output
40W

Lumiere XXS

Halo or LED retrofit 1x42W G9
Dimmer included
minimum Halo bulb output
40W

CE IP 20

Lumiere XXL

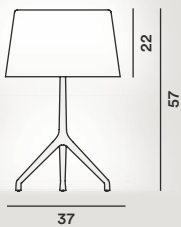

Lumiere XXS

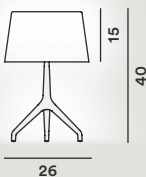

	energy cl.	colours	code	vat excluded
<i>Lumiere XXL</i>	A ⁺ , A, C	alluminio/bianco	191001A 11	747,90
		alluminio/grigio	191001A 24	
		alluminio/marrone	191001A 55	
		cromo nero/bianco	191001C 11	
		cromo nero/grigio	191001C 24	
		cr. nero/marrone	191001C 55	
<i>Lumiere XXS</i>	A ⁺ , A, C	alluminio/bianco	1910012A 11	490,75
		alluminio/grigio	1910012A 24	
		alluminio/marrone	1910012A 55	
		cromo nero/bianco	1910012C 11	
		cromo nero/grigio	1910012C 24	
		cr. nero/marrone	1910012C 55	

Spare parts:

<i>Glass Lumiere XXL</i>	bianco	191S001 11	335,29
	grigio	191S001 24	
	marrone	191S001 55	
<i>Glass Lumiere XXS</i>	bianco	191S002 11	204,20
	grigio	191S002 24	
	marrone	191S002 55	

Glass colours:
bianco, grigio freddo,
marrone freddo



Frame colours:
alluminio, cromo nero



Special colours
on request

Weight:
Lumiere XXL
net kg 5,50

Lumiere XXS
net kg 1,80

Halo, LED retrofit
light bulbs not included
→ specifications p. 190

collection →

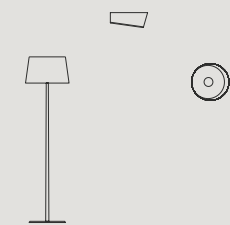

p. 051 p. 138 p. 165



030 Tavolo, *Table*

Magneto

Giulio Iacchetti, 2011

LED



	energy cl.	colours	code	vat excluded
<i>Magneto</i>	A ⁺	bianco	202001R2 10	310,92
		nero	202001R2 20	

Coated steel, ABS and super magnet made of "rare earth"

Colours: bianco, nero

Weight:
net kg 1,30

LED included
Power LED 5W 2700° K
475 lm CRI>80 95 lm/W



Special colours
on request

With personalized packaging

☐ CE IP 20

Tecnico — 2018

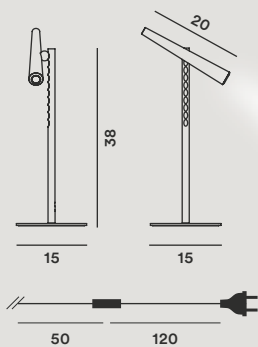

collection →



p. 052

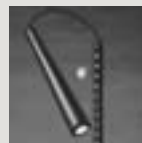

Plass media

Luca Nichetto, 2015



Rotational moulded
polycarbonate and steel

Plass media on/off
LED retrofit or Fluo
1x25W E27
Halo 1x150W E27

Plass media with dimmer
Halo or dimmable LED retrofit
1x150W E27
Dimmer included

CE IP 20

	energy cl.	colours	code	vat excluded
<i>Plass media on/off</i>	A ⁺ , A	grigio	2240012 25	369,75
		azzurro	2240012 30	
<i>Plass media with dimmer</i>	A ⁺ , A	grigio	2240012D 25	390,76
		azzurro	2240012D 30	
Spare parts:				
<i>Lampshade Plass</i>		grigio	224S002R1 25	241,18
		azzurro	224S002R1 30	

Colours: grigio, azzurro

Weight:
net kg 4,00

Halo, Fluo, LED retrofit
light bulbs not included
→ specifications p. 190

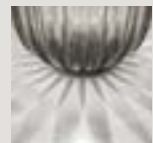
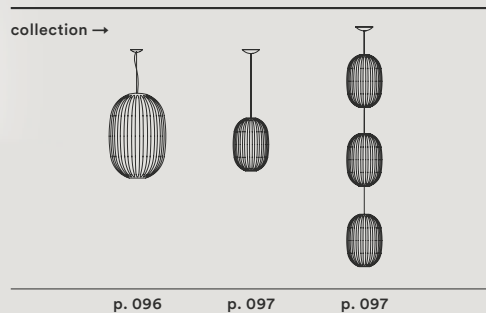
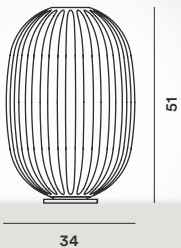
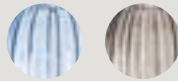

Poly Gregg

Ludovica + Roberto
Palomba, 2011



	energy cl.	colours	code	vat excluded
<i>Poly Gregg X-large</i>	A ⁺ , A	bianco	2180030 10	352,94
<i>Poly Gregg grande</i>	A ⁺ , A	bianco	2180130 10	274,79
<i>Poly Gregg media</i>	A ⁺ , A	bianco	2180230 10	193,28

Spare parts:

<i>Lampshade Poly Gregg X-large</i>	bianco	218S001 10	178,99
<i>Lampshade Poly Gregg grande</i>	bianco	218S00 10	100,84
<i>Lampshade Poly Gregg media</i>	bianco	218S002 10	63,03

Rotational moulded
polyethylene

Poly Gregg X-large or grande
LED retrofit or Fluo
1x25W E27

Poly Gregg media
LED retrofit or Fluo
1x15W E27



Colours: bianco



Weight:
X-large
net kg 4,30

grande
net kg 3,60

media
net kg 1,60

Fluo, LED retrofit light
bulbs not included
→ specifications p. 190

X-large

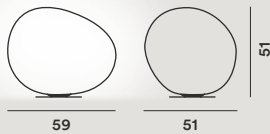

grande

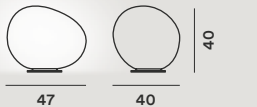

media

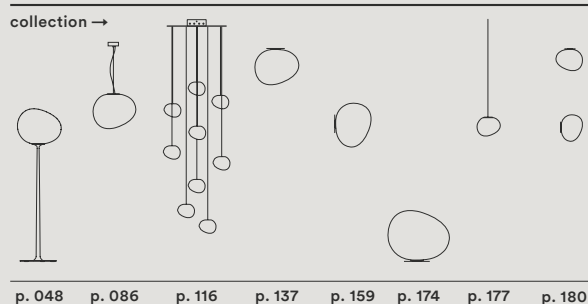

Satellight

Eugeni Quitllet, 2017

LED

Blown glass

LED included
8,4W 2700°K 655 lm CRI>80
Dimmable

	energy cl.	colours	code	vat excluded
<i>Satellight on/off</i>	A ⁺	bianco/trasp.	285021-15	386,55
<i>Satellight with touch dimmer</i>	A ⁺	bianco/trasp.	285021D-15	432,77

Spare parts:

<i>External glass</i>	trasparente	285RV011-15	232,83
<i>Inner glass</i>	bianco	285RV012-10	64,44

Colours:
bianco/trasparente

Weight:
net kg 3,00

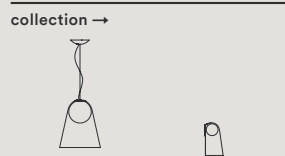
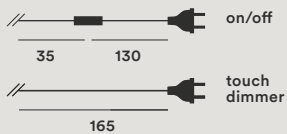
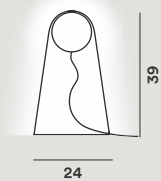

p. 100

p. 168



Rituals + Rituals XL

Ludovica + Roberto
Palomba, 2012 - 2015



	energy cl.	colours	code	vat excluded
<i>Rituals 1 on/off</i>	A ⁺ , A	bianco	2440011 10	335,30
<i>Rituals 1 with dimmer</i>	A ⁺ , A	bianco	2440011D1 10	373,11
<i>Rituals 2 on/off</i>	A ⁺ , A	bianco	2440012 10	335,30
<i>Rituals 2 with dimmer</i>	A ⁺ , A	bianco	2440012D1 10	373,11
<i>Rituals 3 on/off</i>	A ⁺ , A	bianco	2440013 10	279,84
<i>Rituals 3 with dimmer</i>	A ⁺ , A	bianco	2440013D1 10	317,65

Blown engraved satin glass
and coated metal

1-2-3 on/off
LED retrofit or Fluo 1x15W E27
Halo 1x105W E27

Rituals 1-2-3 with dimmer
Halo or dimmable LED
retrofit 105W E27

Rituals XL on/off
LED retrofit or Fluo 1x25W E27
Halo 1x150W E27

Rituals XL with dimmer
dimmable LED retrofit or
Halo 1x150W E27

☐ CE IP 20

Colours: bianco



Weight:
Rituals 1
net kg 4,00

Rituals 2
net kg 4,10

Rituals 3
net kg 1,60

Rituals XL
net kg 6,60

Halo, Fluo, LED retrofit
light bulbs not included
→ specifications p. 190

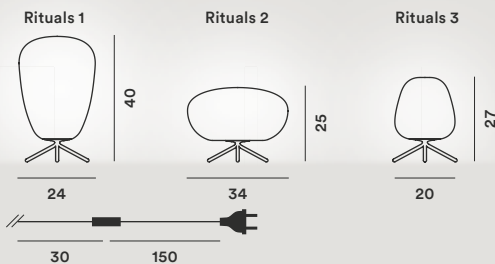

collection →

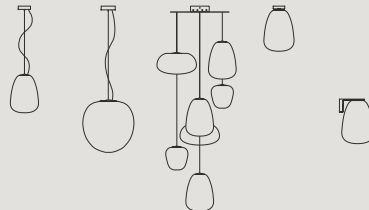

	energy cl.	colours	code	vat excluded
<i>Rituals XL on/off</i>	A ⁺ , A,	bianco	2440014 10	486,56
<i>Rituals XL with dimmer</i>	A ⁺ , A	bianco	2440014D 10	505,89
<hr/>				
<i>Glass Rituals 1</i>		bianco	244S001 10	221,85
<i>Glass Rituals 2</i>		bianco	244S002 10	221,85
<i>Glass Rituals 3</i>		bianco	244S003 10	166,39
<i>Glass Rituals XL</i>		bianco	244S004 10	315,13

Spare parts:

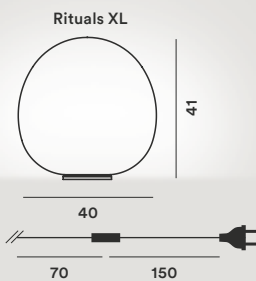

Tress

Marc Sadler, 2009



Varnished fibreglass-based composite material

Tress
dimnable LED retrofit or
Halo 1x100W GU10 PAR
Dimmer included

Tress mini
dimnable LED retrofit or
Halo 1x75W GU10 PAR 20
Dimmer included



	energy cl.	colours	code	vat excluded
<i>Tress</i>	A ⁺ , A	bianco	182001 10	441,17
		nero	182001 20	
		cremisi	182001 67	
		greige	182001 25	
		indaco	182001 87	
<i>Tress mini</i>	A ⁺ , A	bianco	1820012 10	399,16
		nero	1820012 20	
		cremisi	1820012 67	
		greige	1820012 25	
		indaco	1820012 87	
Spare parts:				
<i>Lampshade Tress</i>		bianco	182S01 10	305,88
		nero	182S01 20	
		cremisi	182S01 67	
		greige	182S01 25	
		indaco	182S01 87	
<i>Lampshade Tress mini</i>		bianco	182S0012 10	282,35
		nero	182S0012 20	
		cremisi	182S0012 67	
		greige	182S0012 25	
		indaco	182S0012 87	

Colours: bianco, nero, cremisi, greige, indaco

Weight:
Tress
net kg 3,20

Halo, LED retrofit
light bulbs not included
→ specifications p. 190

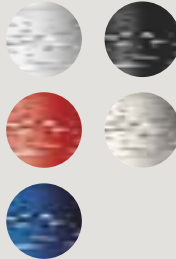

Tress mini
net kg 1,40

Special colours
on request

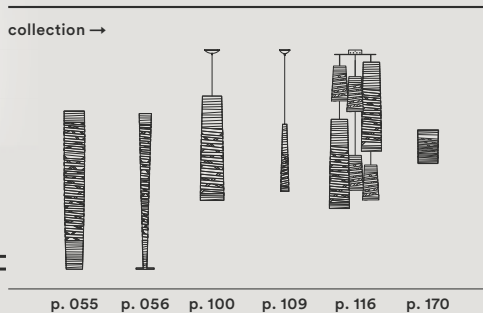
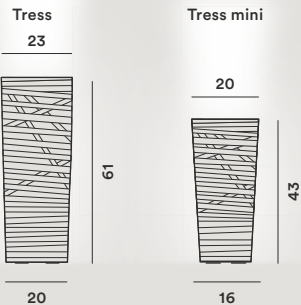

p. 055 p. 056 p. 100 p. 109 p. 116 p. 170



Twiggy XL

Marc Sadler, 2008



	energy cl.	colours	code	vat excluded
<i>Twiggy XL</i>	A ⁺ , A	bianco	1590011 10	754,62
		nero	1590011 20	

Spare parts:

<i>Lampshade Twiggy XL</i>	bianco	159S10 10	463,87
	nero	159S10 20	

Varnished fibreglass-based composite material, polycarbonate and varnished metal

Colours: bianco, nero



Weight:
net kg 6,80

Halo, LED retrofit
light bulbs not included
→ specifications p. 190

Halo or dimmable LED
retrofit 3x77W E27
Dimmer included

Special colours
on request

□ CE IP 20

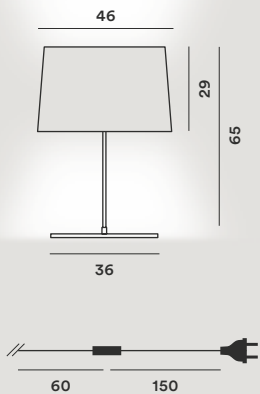

collection →



Uto

Lagranja Design, 2005



	energy cl.	colours	code	vat excluded
<i>Uto</i>	A ⁺ , A	bianco	142000 10	348,74
		giallo	142000 50	
		arancio	142000 53	

Thermoplastic elastomer and polycarbonate

LED retrofit or Fluo
1x15W E27

Switch inside the flexible tube



Colours: bianco, giallo, arancio



Weight:
net kg 2,00

Fluo, LED retrofit
light bulbs not included
→ specifications p. 190

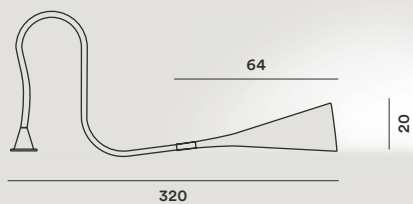

collection →

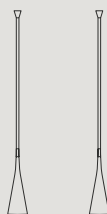

Yoko

Anderssen & Voll, 2013



	energy cl.	colours	code	vat excluded
Yoko	A ⁺ , A	verde*	239001 40	258,82
		arancio*	239001 50	
		viola*	239001 80	
Spare parts:				
Lampshade Yoko		verde	239S00 40	134,45
		arancio	239S00 50	
		viola	239S00 80	

* Limited stock available

PMMA / polycarbonate

LED retrofit or Fluo
1x25W E27

IP 20

Colours:
verde*, arancio*,
viola*

* Limited stock available

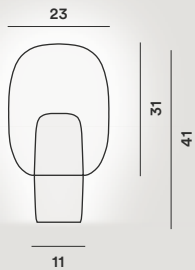
Weight:
net kg 2,00Fluo, LED retrofit
light bulbs not included
→ specifications p. 190

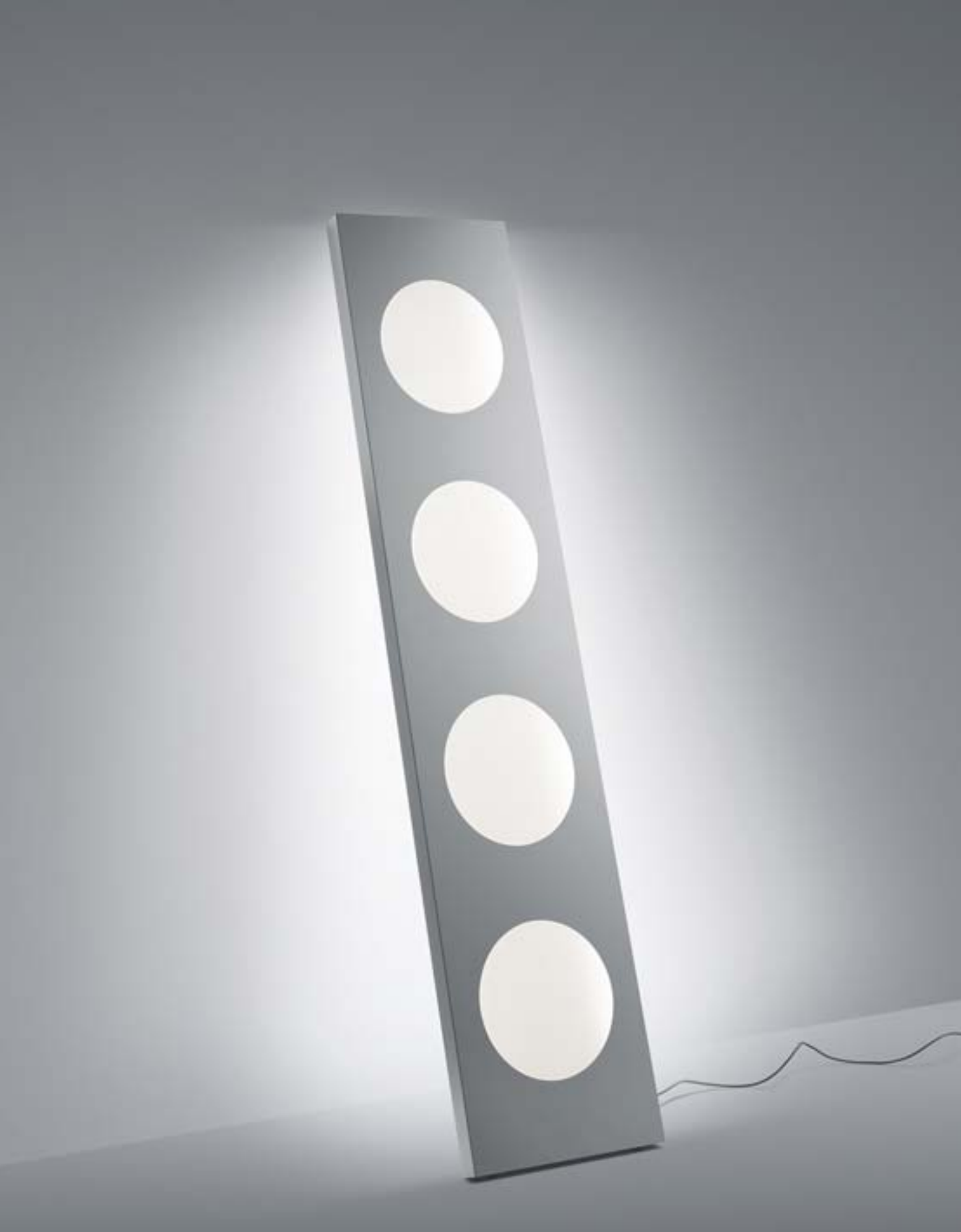

Terra, *Floor*

- | | | | |
|-----|--------------------|-----|------------------------------|
| 042 | Aplomb | 052 | Magneto |
| 043 | Birdie | 053 | Mite |
| 044 | Caboche | 054 | Orbital |
| 045 | Dolmen | 055 | Tress |
| 046 | Filo | 056 | Tress Stilo |
| 047 | Giga-Lite | 057 | Tuareg |
| 048 | Gregg | 058 | Twice |
| 049 | Havana | | as Twiggy |
| 050 | Lightwing | 059 | Twiggy |
| 051 | Lumiere XXL | 060 | Twiggy <i>lettura</i> |

Aplomb

Lucidi e Pevere, 2013



	energy cl.	colours	code	vat excluded
Aplomb terra	A ⁺ , A, C	bianco*	195003 10	642,85
		grigio*	195003 25	
		marrone*	195003 52	

* Limited stock available

Concrete and coated metal

Halo or LED retrofit
1x150W R7s
Dimmer included
minimum Halo bulb output
60W

CE IP 20

Colours: bianco*, grigio
cemento*, marrone*

* Limited stock available

Weight:
net kg 8,50

Halo, LED retrofit
light bulbs not included
→ specifications p. 190

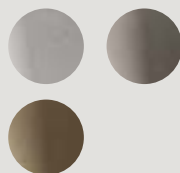

Tecnico — 2018

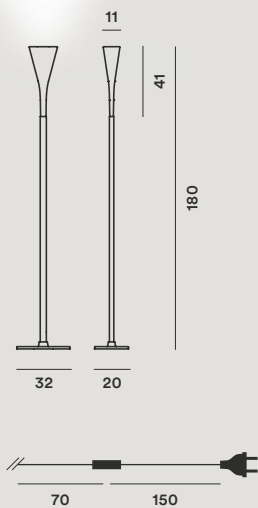

p. 066 p. 068 p. 116 p. 146

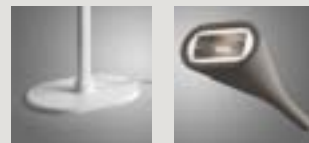

Birdie

Ludovica + Roberto
Palomba, 2011



Polycarbonate, coated steel
and metal

Birdie lettura on/off
LED retrofit or Fluo
1x25W E27
Halo 1x150W E27

*Birdie lettura with integrated
touch dimmer*
Halo or dimmable LED
retrofit 1x150W E27

CE IP 20

	energy cl.	colours	code	vat excluded
<i>Birdie lettura on/off</i>	A ⁺ , A	bianco	221004S 10	327,73
		grigio	221004S 25	
		arancio	221004S 53	
		amaranto	221004S 65	
<i>Birdie lettura with touch dimmer</i>	A ⁺ , A	bianco	221004 10	369,75
		grigio	221004 25	
		arancio	221004 53	
		amaranto	221004 65	
Spare parts:				
<i>Lampshade Birdie</i>		bianco	221S00 10	65,55
		grigio	221S00 25	
		arancio	221S00 53	
		amaranto	221S00 65	

Colours: bianco, grigio,
arancio, amaranto

Weight:
net kg 4,30

Halo, Fluo, LED retrofit
light bulbs not included
→ specifications p. 190



Special colours
on request

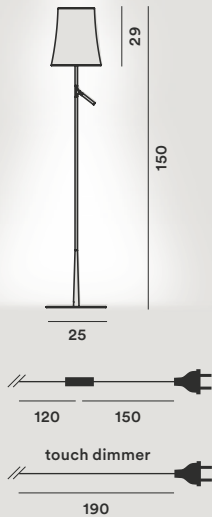

collection →

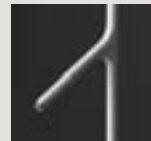
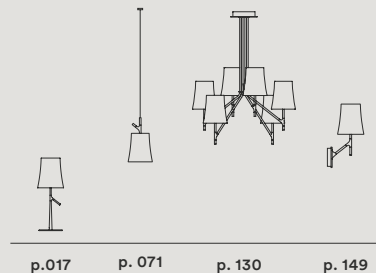

Caboche

Patricia Urquiola
con Eliana Gerotto, 2005



Polymethylmethacrylate,
blown glass and white
lacquered metal

Caboche grande
Halo or dimmable LED
retrofit 1x230W R7s
Dimmer included
minimum Halo bulb output
60W

Caboche media
Halo or dimmable LED
retrofit 1x160W R7s
Dimmer included
minimum Halo bulb output
60W

☐ CE ⚡ IP 20

	energy cl.	colours	code	vat excluded
Caboche grande	A ⁺ , A, C	trasparente	138013 16	1.672,27
		giallo oro	138013 52	
Caboche media	A ⁺ , A, C	trasparente	138003 16	1.078,15
		giallo oro	138003 52	

Spare parts:

Kit 10 sphere Caboche	trasparente	138KIT 10SF16	39,50
	giallo oro	138KIT 10SF52	
Kit 20 prongs 4 spheres Caboche grande		138KIT 20G4	36,97
Kit 20 prongs 5 spheres Caboche grande		138KIT 20G5	36,97
Kit 3+3 prongs 4+5 spheres Caboche grande		138KIT1-R2	20,17
Kit 15 prongs 3 spheres Caboche media		138KIT 15M3	29,41
Kit 15 prongs 4 spheres Caboche media		138KIT 15M4	29,41
Kit 3+3 prongs 3-4 spheres Caboche media		138KIT-R2	21,01
Glass Caboche grande		138V011/I	120,17
Glass Caboche media		138V01R1/I	79,83
Halogen protection glass		PIREX138/2S4I	20,17
Halo. protection disk Caboche grande		138V021/I	48,74
Halo. protection disk Caboche media		138V02/I	36,97

Colours: trasparente,
giallo oro

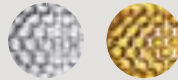

Weight:
Caboche grande
net kg 23,90

Caboche media
net kg 11,80

Halo, LED retrofit
light bulbs not included
→ specifications p. 190

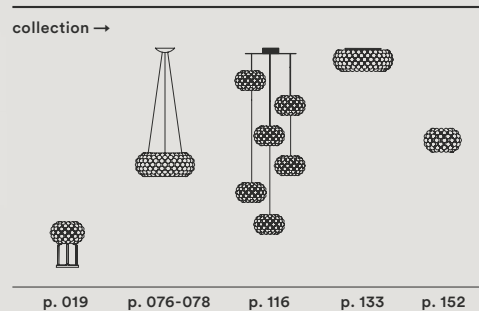
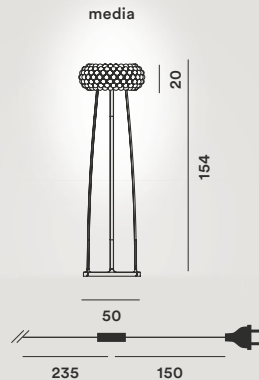
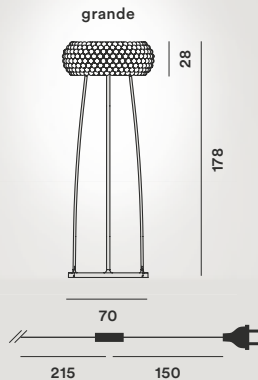

Dolmen

Ferruccio Laviani,
1996/2017

LED



	energy cl.	colours	code	vat excluded
<i>Dolmen</i>	A ⁺	alluminio	280003-25	1.344,54
		arancio	280003-14	1.487,39
		bronzo	280003-73	1.487,39

Varnished or anodised
aluminium and PMMA

LED included
47W 2700°K 6486 lm
CRI>90 138 lm/W
Dimmer included

CE IP 20

Colours: alluminio,
arancione, bronzo



Weight:
net kg 12,50

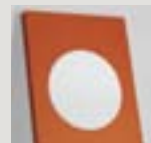
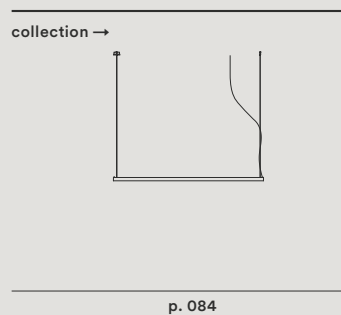
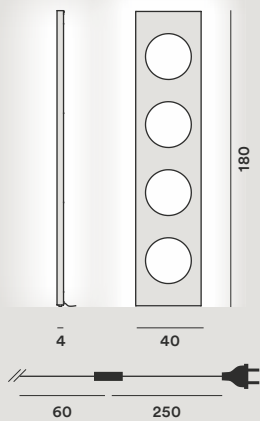

046 Terra, Floor

Filo

Andrea Anastasio, 2017



	energy cl.	colours	code	vat excluded
Filo lettura	A ⁺	amethyst queen	289004-01	386,55
		eastern coral	289004-02	
		teodora	289004-04	
		emerald king	289004-08	

Porcelain, textile cable, blown glass and varnished metal

LED retrofit included
4W G9 3000°K
400 lm CRI>80



Colours:

Amethyst Queen

Eastern Coral

Weight:
net kg 5,70

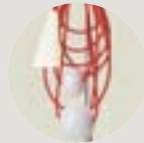
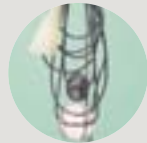

Teodora

Emerald King

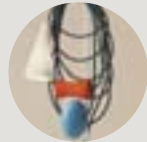

Tecnico — 2018

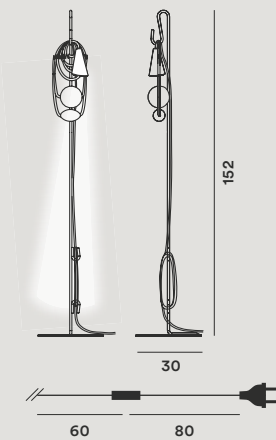

collection →

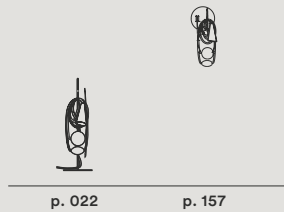

p. 022

p. 157



Giga-Lite

Marc Sadler, 2004



Fibreglass fabric, carbonium thread and stainless steel

Extendable

Halo or dimmable LED retrofit 3x100W E27
Dimmer included



	energy cl.	colours	code	vat excluded
<i>Giga-Lite</i>	A ⁺ , A	nero	139013 20	915,97
Spare parts:				
<i>Lampshade Giga-Lite</i>		nero	139S001 20	371,43

Colours: nero



Weight:
net kg 9,80

Halo, LED retrofit
light bulbs not included
→ specifications p. 190

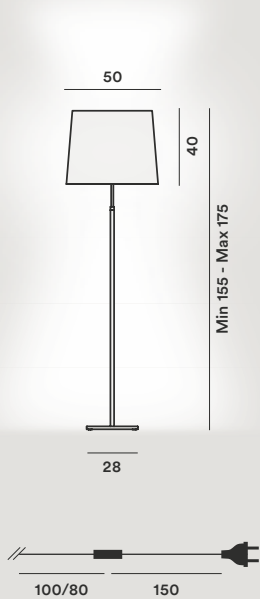

collection →

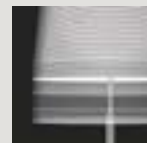
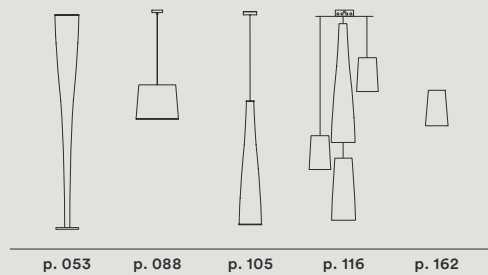

Gregg

Ludovica + Roberto
Palomba, 2010

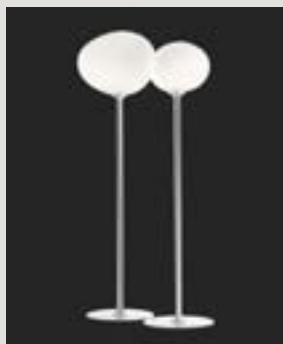

Blown acid-etched glass,
lacquered polyurethane and
metal

Halo or dimmable LED
retrofit 1x205W E27
Dimmer included



	energy cl.	colours	code	vat excluded
<i>Gregg grande</i>	A ⁺ , A	bianco	168013A 10	816,81
<i>Gregg media</i>	A ⁺ , A	bianco	168003A 10	670,59

Spare parts:

<i>Glass Gregg grande</i>	bianco	168S0031 10	317,65
<i>Glass Gregg media</i>	bianco	168S00 10	171,43

Colours: bianco



Weight:
Gregg grande
net kg 14,70

Gregg media
net kg 11,70

Halo, LED retrofit
light bulbs not included
→ specifications p. 190

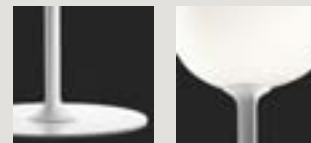
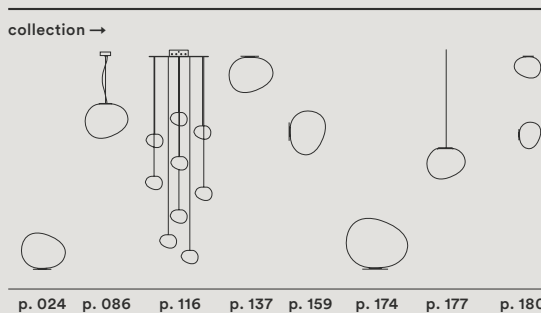
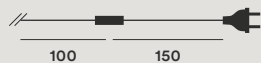
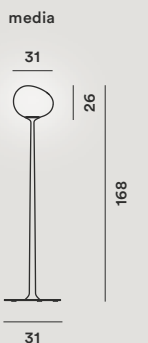
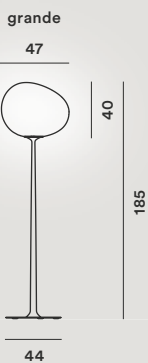

Havana

Joseph Forakis, 1993



Injection moulded polyethylene and coated or chromed metal

Havana on/off
LED retrofit or Fluo
1x25W E27
Halo 1x116W E27

Havana with dimmer
Halo or dimmable LED retrofit 1x116W E27
Dimmer included

CE IP 20

	energy cl.	colours	code	vat excluded
<i>Havana on/off</i>	A ⁺ , A	allum./bianco	040003 10	297,48
<i>Havana on/off</i>	A ⁺ , A	cromo/bianco	040003C 10	352,94
<i>Havana with dimmer</i>	A ⁺ , A	allum./bianco	040003 10 D	312,60
<i>Havana with dimmer</i>	A ⁺ , A	cromo/bianco	040003C 10 D	368,07
Spare parts:				
<i>Set lampshades Havana</i>		bianco	040S00 10	78,99

Lampshade colours:
bianco



Frame colours:
alluminio, cromo



Weight:
net kg 3,30

Halo, Fluo, LED retrofit
light bulbs not included
→ specifications p. 190

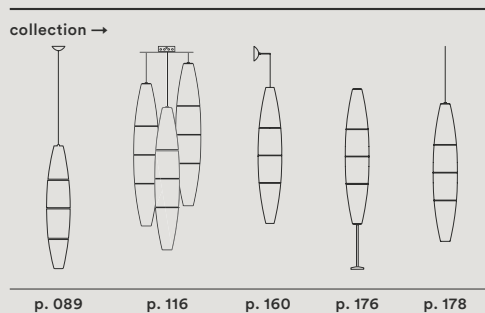
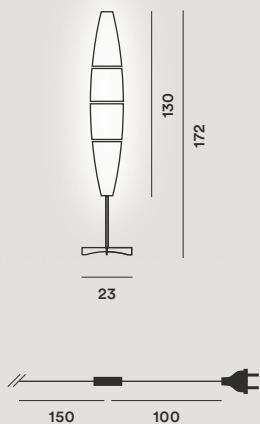

050 Terra, Floor

Lightwing

Jean Marie Massaud, 2013



	energy cl.	colours	code	vat excluded
<i>Lightwing</i>	A ⁺	bianco	249003 10	1.263,87
		nero	249003 20	

Varnished aluminum and zinc alloy

LED included
Mid-power 34W 3000°K
3157 lm CRI > 90 92,9 lm/W
Dimmer included

Adjustable lampshade



Colours: bianco, nero



Special colours on request

Weight:
net kg 11,00

LED and dimming
→ specifications p. 189

Tecnico — 2018

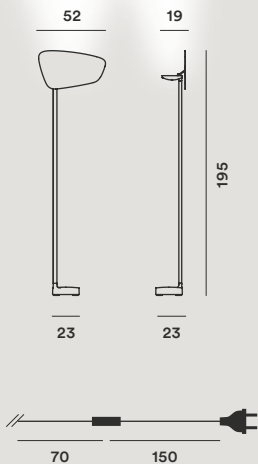

Lumiere XXL

Rodolfo Dordoni, 2015



	energy cl.	colours	code	vat excluded
<i>Lumiere XXL</i>	A ⁺ , A, C	alluminio/bianco	191004A 11	1.000,00
		alluminio/grigio	191004A 24	
		alluminio/marrone	191004A 55	
		cromo nero/bianco	191004C 11	
		cromo nero/grigio	191004C 24	
		cr. nero/marrone	191004C 55	

Spare parts:

<i>Glass Lumiere XXL</i>	bianco	191S001 11	335,29
	grigio	191S001 24	
	marrone	191S001 55	

Blown glass and lacquered aluminium

Halo or LED retrofit
4x33W G9
Dimmer included
minimum Halo bulb output
60W



Glass colours:
bianco, grigio freddo,
marrone freddo

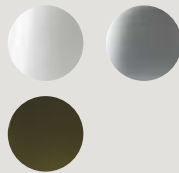

Frame colours:
alluminio, cromo nero



Special colours
on request

Weight:
net kg 16,5

Halo, LED retrofit
light bulbs not included
→ specifications p. 190

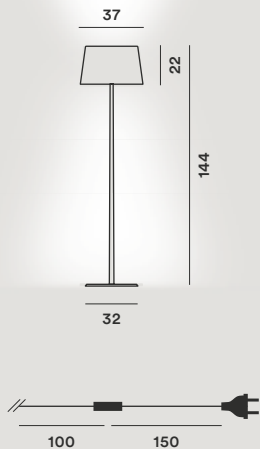

collection →



p. 029 p. 138 p. 165



Magneto

Giulio Iacchetti, 2011



	energy cl.	colours	code	vat excluded
<i>Magneto</i>	A ⁺	bianco	202004R2 10	386,55
		nero	202004R2 20	

Coated steel, ABS and super magnet made of "rare earth"

Colours: bianco, nero

Weight:
net kg 2,80

LED included
Power LED 5W 2700° K
475 lm CRI>80 95 lm/W



Special colours
on request



Tecnico — 2018

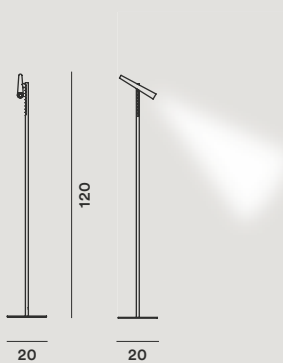

collection →



p. 030



Mite

Marc Sadler, 2000

LED



	energy cl.	colours	code	vat excluded
<i>Mite</i>	A ⁺ , A	giallo	111003R2 55	805,04
		nero	111003R2 20	
<i>Mite LED</i>	A	giallo	111003L 55	1.117,65
		nero	111003L 20	
Spare parts:				
<i>Lampshade Mite</i>		giallo	111S00 55	426,89
		nero	111S00 20	

Fibreglass fabric with Kevlar or carbonium thread, nickel-plated metal, steel and aluminium (LED)
Kevlar® is a Dupont registered trademark

Colours: giallo, nero



Weight:

Mite
net kg 7,70

Mite LED
net kg 7,70

Halo, LED retrofit
light bulbs not included
→ specifications p. 190



Compasso
D'Oro 2001

Mite

Halo or dimmable LED
retrofit 1x150W E27
Dimmer included

Mite LED

LED included
32,9W COB 3000°K 3580 lm
CRI>90 109 lm/W
Dimmer included

CE IP 20

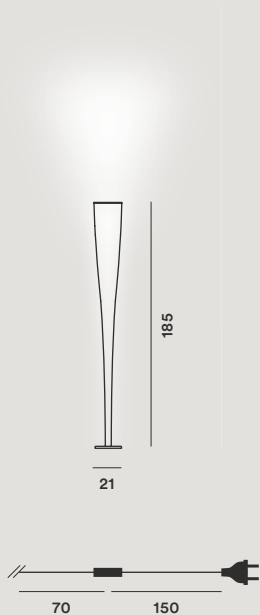

collection →

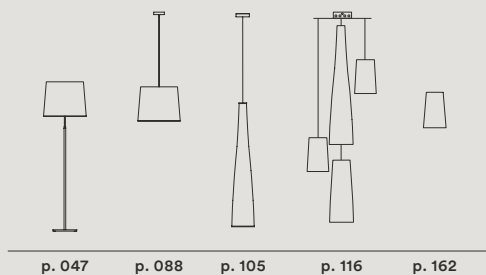

Orbital

Ferruccio Laviani, 1992



Silkscreen-printed glass and lacquered metal

LED retrofit or Halo
5x30W E14



	energy cl.	colours	cod	vat excluded
Orbital	A ⁺ , A	bianco	036003 10	865,55
		colorato	036003	
Spare parts:				
Glass set Orbital		bianco	036S01 10	220,17
		colorato	036S01	
Glass Orbital 1		bianco	043S00/1 10	50,42
		rosso	043S00/1 63	
Glass Orbital 2		bianco	043S00/2 10	50,42
		blu	043S00/2 33	
Glass Orbital 3		bianco	043S00/3 10	50,42
Glass Orbital 4		bianco	043S00/4 10	50,42
		verde	043S00/4 40	
Glass Orbital 5		bianco	043S00/5 10	50,42
		arancio	043S00/5 52	

Colours: bianco, colorato

Weight:
net kg 10,10

Halo, LED retrofit
light bulbs not included
→ specifications p. 190



Special colours
on request

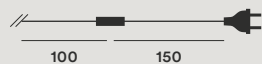
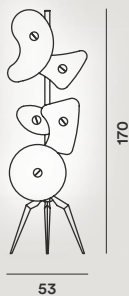

collection →



Tress

Marc Sadler, 2008



Compound material on lacquered fibre base, coated metal and aluminium

Tress grande
Halo or LED retrofit
1x300W R7s
+ LED retrofit or Halo
1x100W E27 PAR
Dimmer included
Double switch

Tress grande LED
LED included
51,7W (39 COB + 6,3 Mid-power + 12,7 COB) 2700° K
5254 lm CRI>90 101,6 lm/W
Dimmer included
Double switch
☐ CE IP 20

Tress media
dimmable LED retrofit or Halo 1x100W E27 PAR
Dimmer included
☐ CE IP 20

	energy cl.	colours	code	vat excluded
Tress grande	A ⁺ , A	bianco	182003 10	1.226,89
		nero	182003 20	
		cremisi	182003 67	
		greige	182003 25	
		indaco	182003 87	
Tress grande LED	A	bianco	182003L 10	1.726,05
		nero	182003L 20	
		cremisi	182003L 67	
		greige	182003L 25	
		indaco	182003L 87	
Tress media	A ⁺ , A	bianco	182004 10	659,67
		nero	182004 20	
		cremisi	182004 67	
		greige	182004 25	
		indaco	182004 87	

Spare parts:

Lampshade Tress media	bianco	182S02 10	490,76
	nero	182S02 20	
	cremisi	182S02 67	
	greige	182S02 25	
	indaco	182S02 87	
Halogen protection glass Tress grande		PIREX138/2S4I	20,17

Colours: bianco, nero, cremisi, greige, indaco

Weight:
Tress grande
net kg 8,50

Halo, LED retrofit light bulbs not included
→ specifications p. 190

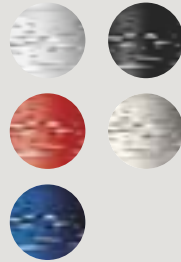

Tress media
net kg 3,90

Tress grande LED
net kg 11,00

Special colours on request

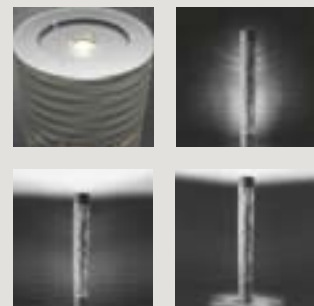
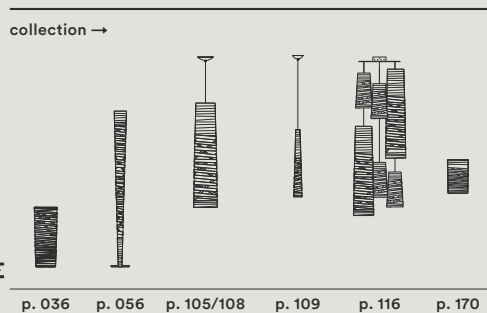
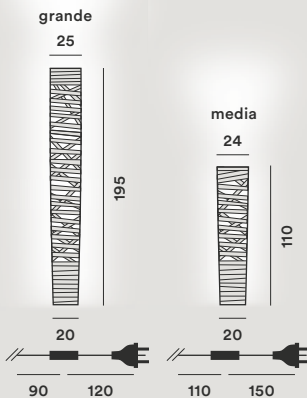

Tress Stilo

Marc Sadler, 2011



	energy cl.	colours	code	vat excluded
<i>Tress Stilo</i>	A ⁺ , A	bianco	182043 10	772,26
		nero	182043 20	

Spare parts:

<i>Lampshade Tress Stilo</i>	bianco	182S143 10	462,18
	nero	182S143 20	

Coated fibreglass-based composite material, lacquered metal and steel

dimmable LED retrofit or Halo 1x100W E27 PAR
Dimmer included



Colours: bianco, nero



Special colours on request

Weight:
net kg 4,20

Halo, LED retrofit light bulbs not included
→ specifications p. 190

Tecnico — 2018

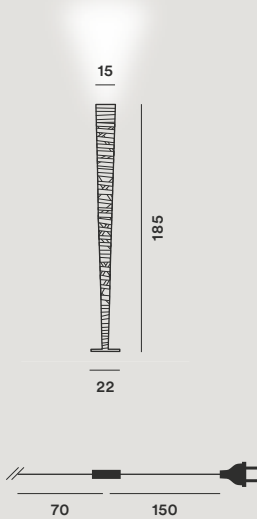

collection →

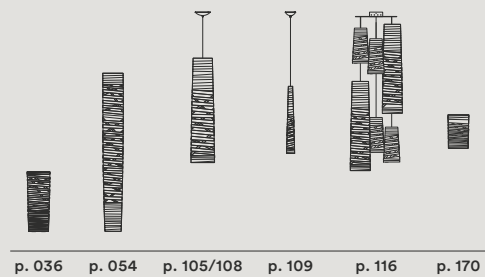

Tuareg

Ferruccio Laviani, 2013

LED



	energy cl.	colours	code	vat excluded
<i>Tuareg</i>	A	bianco	255003 10	2.672,27
		arancio	255003 53	2.672,27
		cromo nero	255003 78	3.008,40

Varnished aluminium and polycarbonate

LED included
54W (3x18 Mid-power)
3000°K 4050 lm
CRI > 90 75 lm/W
3 separate switches and integrated touch dimmer
orientable lights

CE IP 20

Colours: bianco, arancio, cromo nero
Weight: net kg 9,20

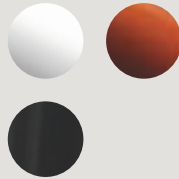

Special colours on request

LED and dimming
→ specifications p. 189

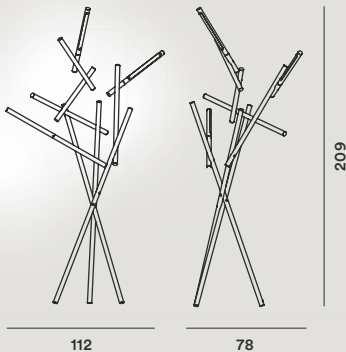

Twice as Twiggy

Marc Sadler, 2015



	energy cl.	colours	code	vat excluded
<i>Twice as Twiggy</i>	A ⁺	bianco	275013 10	4.953,79
		nero	275013 20	
		greige	275013 25	
		cremisi	275013 67	
		indaco	275013 87	

Spare parts:

<i>Lampshade Twice as Twiggy</i>	bianco	275S001 10	1.917,65
	nero	275S001 20	
	greige	275S001 25	
	cremisi	275S001 67	
	indaco	275S001 87	

Coated fibreglass-based composite material, PMMA, polycarbonate, coated metal and aluminium.

LED included
81W (54+27 Mid-power)
3000° K 8517 lm
CRI>90 106 lm/W
Dimmer included



Colours: bianco, nero, cremisi, greige, indaco

Weight:
net kg 57,60

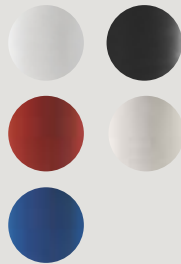

Special colours on request

Tecnico — 2018

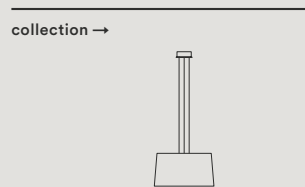
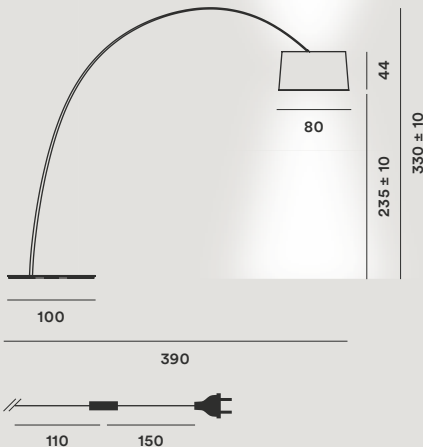

Twiggy

Marc Sadler, 2006



Coated fibreglass-based composite material, PMMA, polycarbonate, coated metal and aluminium (LED)

Twiggy
Halo or dimmable LED retrofit 3x77W E27
Dimmer included

Twiggy LED
LED included
33W (25+8 Mid-power) 3000° K
3448 lm CRI>90 104,5 lm/W
Dimmer included

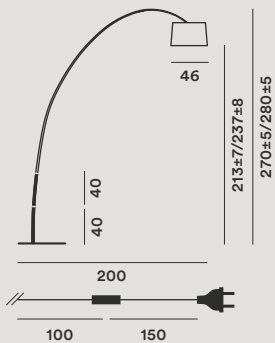

Colours: bianco, nero, cremisi, greige, indaco

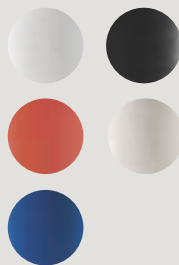

Special colours on request

Weight:
Twiggy
net kg 16,60

Twiggy LED
net kg 17,10

Halo LED retrofit light bulbs not included → specifications p. 190

LED and dimming → specifications p. 189

	energy cl.	colours	code	vat excluded
Twiggy	A ⁺ , A	bianco	159003 10	1.084,03
		nero	159003 20	
		greige	159003 25	
		cremisi	159003 67	
		indaco	159003 87	
Twiggy LED	A ⁺	bianco	159003L 10	1.516,80
		nero	159003L 20	
		greige	159003L 25	
		cremisi	159003L 67	
		indaco	159003L 87	

Accessories:

Additional stem set Twiggy (40 cm + 40 cm)	bianco	159S031 10	168,07	
	nero	159S031 20		
	greige	159S031 25		
	cremisi	159S031 67		
	indaco	159S031 87		

Spare parts:

Lampshade Twiggy	bianco	159S10 10	463,87
	nero	159S10 20	
	greige	159S10 25	
	cremisi	159S10 67	
	indaco	159S10 87	
Lower diffusor disk		159R05	32,77

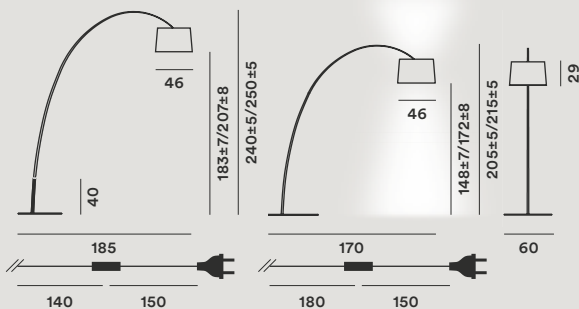

Twiggy Lettura

Marc Sadler, 2008



	energy cl.	colours	code	vat excluded
<i>Twiggy lettura</i>	A ⁺ , A	bianco	159004 10	903,36
		nero	159004 20	
Spare parts:				
<i>Lampshade Twiggy</i>		bianco	159S10 10	463,87
		nero	159S10 20	

Coated fibreglass-based composite material, PMMA, polycarbonate and coated metal

Halo or dimmable LED retrofit 3x77W E27
Dimmer included

☐ Ⓒ IP 20

Colours: bianco, nero



Special colours on request

Weight:
net kg 11,30

Halo, LED retrofit light bulbs not included
→ specifications p. 190

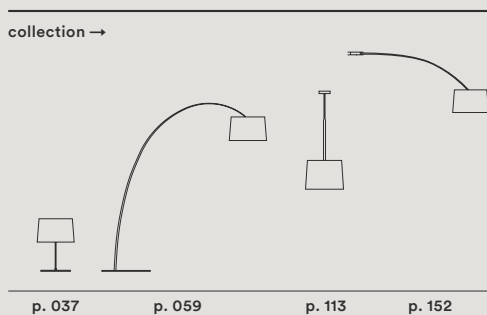
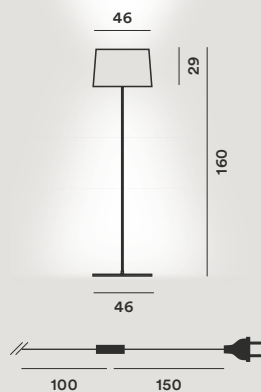



Sospensione, *Suspension*

- | | | | |
|-----|-------------------|-----|------------------------|
| 064 | Allegretto | 092 | Lightweight |
| 065 | Allegro | 093 | Maki |
| 066 | Aplomb | 094 | O-Space |
| 069 | Arumi | 095 | Planet |
| 070 | Behive | 096 | Plass |
| 072 | Big Bang | 098 | Rituals |
| 071 | Birdie | 100 | Satellite |
| 074 | Buds | 102 | Spokes |
| 076 | Caboche | 101 | Supernova |
| 079 | Caiigo | 104 | Tartan |
| 080 | Chouchin | 105 | Tite |
| 084 | Dolmen | 106 | Tress |
| 085 | Gem | 109 | Tress Stilo |
| 088 | Giga-Lite | 110 | Troag |
| 086 | Gregg | 111 | Tropico |
| 089 | Havana | 112 | Twice as Twiggy |
| 090 | Jamaica | 113 | Twiggy |
| 091 | Le Soleil | 114 | Uto |

Allegretto

Atelier Oi, 2009



	energy cl.	colours	code	vat excluded
<i>Allegretto Ritmico</i>	A ⁺ , A	grafite	1690171 20	1.491,18
<i>Allegretto Vivace</i>	A ⁺ , A	rame	1690172 80	1.785,30
<i>Allegretto Assai</i>	A ⁺ , A	oro	1690173 71	2.047,49
<i>Allegretto Ritmico h. 10 m</i> •	A ⁺ , A	grafite	1690171/10-20	1.653,22
<i>Allegretto Vivace h. 10 m</i> •	A ⁺ , A	rame	1690172/10-80	1.947,34
<i>Allegretto Assai h. 10 m</i> •	A ⁺ , A	oro	1690173/10-71	2.209,53

Accessories:

<i>Decentralization kit</i> for steel cables	KIT DEC B	27,73
for steel cables + canopy	KIT DEC F	48,74

Varnished aluminium and metal

LED retrofit
2x12W E27 PAR 30
Halo 2x100W E27 PAR 30



Colours:
Assai oro,
Vivace rame,
Ritmico grafite

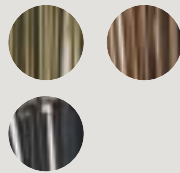

Special colours
on request

Weight:
Allegretto Ritmico
net kg 5,10

Allegretto Vivace
net kg 9,10

Allegretto Assai
net kg 11,30

•
H. 10 m on demand:
lead times to be
checked with the
sales department

Halo, LED retrofit light
bulbs not included
→ specifications p. 190

Decentralization
→ specifications p. 124

Ritmico

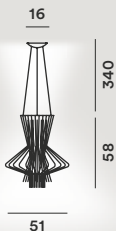

Vivace

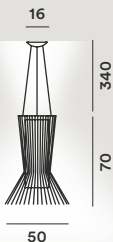

Assai



Allegro

Atelier Oi, 2007

LED



Varnished aluminium and metal

Allegro LED included
51W (39,4 COB + 11 Multichip)
3000°K 4890 lm
CRI>90 124 lm/W
Dimmable
Possible configurations:
On-Off/Push/DALI

Allegro
LED retrofit o
Halo 1x230W R7s +
LED retrofit o
Halo 1x100W E27 PAR 30

Double switch

Ⓢ CE IP 20

	energy cl.	colours	code	vat excluded
<i>Allegro Ritmico LED</i>	A ⁺	grafite	1690071L 20	2.890,76
<i>Allegro Vivace LED</i>		rame	1690072L 80	3.731,09
<i>Allegro Assai LED</i>		oro	1690073L 71	5.462,19
<i>Allegro Ritmico</i>	A ⁺ , A, C	grafite	1690071 20	2.554,62
<i>Allegro Vivace</i>		rame	1690072 80	3.394,95
<i>Allegro Assai</i>		oro	1690073 71	5.126,05
<i>Allegro Ritmico LED h. 10 m • A⁺</i>		grafite	1690071L/1020	3.040,76
<i>Allegro Vivace LED h. 10 m •</i>		rame	1690072L/1080	3.881,09
<i>Allegro Assai LED h. 10 m •</i>		oro	1690073L/1071	5.612,19
<i>Allegro Ritmico h. 10 m • A⁺, A, C</i>		grafite	1690071/10-20	2.679,27
<i>Allegro Vivace h. 10 m •</i>		rame	1690072/10-80	3.519,60
<i>Allegro Assai h. 10 m •</i>		oro	1690073/10-71	5.250,70

Spare parts:

<i>Halogen protection glass</i>	PIREX138/4/1	26,89
---------------------------------	--------------	-------

Accessories:

<i>Decentralization kit for steel cables</i>	KIT DEC B	27,73
<i>for steel cables + canopy</i>	KIT DEC F	48,74

Colours:

Assai oro,
Vivace rame,
Ritmico grafite

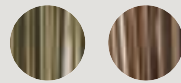

Special colours
on request

Weight:

Allegro Ritmico
net kg 15,00

Allegro Vivace
net kg 19,30

Allegro Assai
net kg 36,00

Allegro Ritmico LED
net kg 13,80

Allegro Vivace LED
net kg 18,10

Allegro Assai LED
net kg 34,80

Halo, LED retrofit

light bulbs not included
→ specifications p. 190

Decentralization
→ specifications p. 124

LED and dimming
→ specifications p. 189

•

H. 10 m on demand:
lead times to be
checked with the sales
department

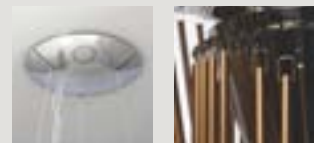
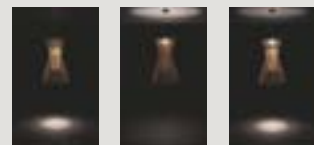
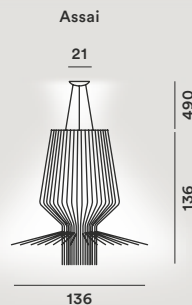
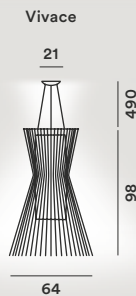
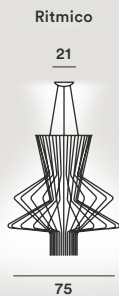

Aplomb

Lucidi e Pevere, 2010



Concrete and aluminium

Aplomb G9
Halo or LED retrofit 1x60W



Aplomb GU10
LED retrofit 1x8W PAR 16



	energy cl.	colours	code	vat excluded
Aplomb G9	A ⁺ , A, C	bianco	195007R1-10	304,63
		grigio	195007R1-25	
		marrone	195007R1-52	
Aplomb GU10	A ⁺ , A	bianco	195007L/3-10	304,63
		grigio	195007L/3-25	
		marrone	195007L/3-52	
		verde	195007L/3-43	
		giallo	195007L/3-56	
Aplomb G9 h. 10 m •	A ⁺ , A, C	bianco	195007R1/1010	350,15
		grigio	195007R1/1025	
		marrone	195007R1/1052	
Aplomb GU10 h. 10 m •	A ⁺ , A	bianco	195007L/10-10	350,15
		grigio	195007L/10-25	
		marrone	195007L/10-52	
		verde	195007L/10-43	
		giallo	195007L/10-56	
		rosso	195007L/10-64	

Accessories:

Decentralization kit for power cable	KIT DEC C	32,77
canopy for electrical dec.	KIT DEC M	85,71

Colours: bianco, grigio cemento, marrone, verde oliva, giallo sabbia, rosso mattone.



Weight:
net kg 1,90

• **H. 10 m on demand:**
lead times to be checked with the sales department

Halo, LED retrofit light bulbs not included
→ specifications p. 190

Multiple canopy
→ specifications p. 116

Decentralization
→ specifications p. 124

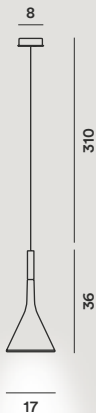

p. 042 p. 116 p. 146

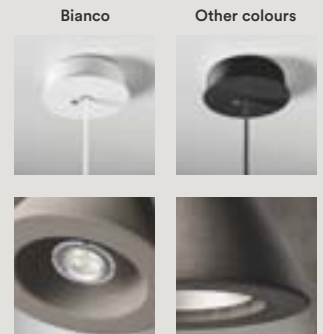

Aplomb Large

Lucidi e Pevere, 2016

LED



Concrete, aluminium and polycarbonate

LED Included
11,7W Multichip mid power
2700° K 1279 lm
CRI>90 109 lm/W
Dimmable LED version
Possible configurations:
On-Off/Push/DALI

	energy cl.	colours	code	vat excluded
<i>Aplomb large</i>	A ⁺	bianco	195017 10	506,30
		grigio	195017 25	
		marrone	195017 52	
<i>Aplomb large dimmable</i>	A ⁺	bianco	195017D 10	552,52
		grigio	195017D 25	
		marrone	195017D 52	
<i>Aplomb large h. 10 m •</i>	A ⁺	bianco	195017/10-10	533,60
		grigio	195017/10-25	
		marrone	195017/10-52	
<i>Aplomb large dimmable h. 10 m •</i>	A ⁺	bianco	195017D/10-10	579,82
		grigio	195017D/10-25	
		marrone	195017D/10-52	

Accessories:

<i>Decentralization kit</i> for power cable	KIT DEC C	32,77
---	-----------	-------

Colours: *bianco*,
grigio cemento,
marrone



Weight:
net kg 4,00

LED and dimming
→ specifications p. 189

• **H. 10 m on demand:**
lead times to be
checked with the
sales department

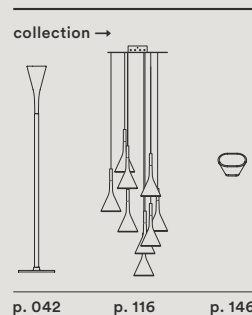
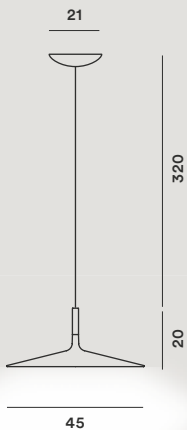

Aplomb mini

Lucidi e Pevere, 2015

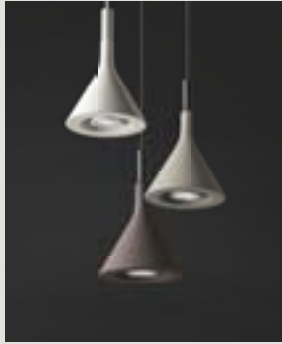

	energy cl.	colours	code	vat excluded
<i>Aplomb mini</i>	A+, A	bianco	195027R1-10	220,59
		grigio	195027R1-25	
		marrone	195027R1-52	
<i>Aplomb mini h. 10 m</i> •	A+, A	bianco	195027R1/1010	266,11
		grigio	195027R1/1025	
		marrone	195027R1/1052	

Accessories:

<i>Decentralization kit</i> for power cable	KIT DEC C	32,77
canopy for electrical dec.	KIT DEC M	85,71

Concrete

LED retrofit GU10
1x8W PAR 16



Colours: bianco, grigio
cemento, marrone



Weight:
net kg 0,70

•
H. 10 m on demand:
lead times to be
checked with the
sales department

LED retrofit light bulbs
not included
→ specifications p. 190

Multiple canopy
→ specifications p. 116

Decentralization
→ specifications p. 124



p. 042

p. 116

p. 146

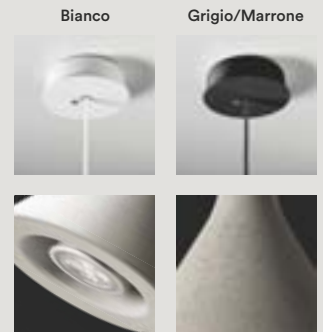

Arumi

Lucidi e Pevere, 2017

LED



	energy cl.	colours	code	vat excluded
<i>Arumi</i>	A	alluminio	282027-77	279,83
<i>Arumi h. 10 m •</i>	A	alluminio	282027/10-77	353,37

Accessories:

<i>Decentralization kit</i> for power cable	KIT DEC C	32,77
canopy for electrical dec.	KIT DEC M	85,71

Alluminium

LED included
COB 10W 2700°K
850 lm CRI>80
Dimmable with TRIAC
technology

⊕ CE IP 20

Colours: alluminio



Weight:
net kg 1,00

LED and dimming
→ specifications
p. 189

- **H. 10 m on demand:**
lead times to be
checked with the
sales department

Attention: the designers and the company chose to emphasize the material and the manual finishing of the lamp's external surface, leaving it rough and with no protective coating, in order to produce a chromatic alteration over time. On the other hand, it is possible to remove finger prints or dirt, cleaning only the external rough surface with water and a mild detergent with neutral-physiological pH factor.

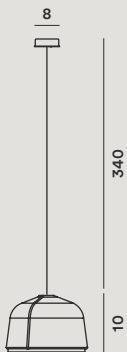

Behive

Werner Aisslinger, 2012



Batch-dyed ABS and polycarbonate

LED retrofit or Fluo 1x25W E27
Halo 1x150W E27



	energy cl.	colours	code	vat excluded
<i>Behive</i>	A ⁺ , A	bianco	203007 10	453,78
<i>Behive h. 10 m •</i>	A ⁺ , A	bianco	203007/10-10	526,60

Spare parts:

<i>Lampshade Behive</i>	bianco	203S007 10	210,92
<i>Protection glass</i>		203V02/1	48,74

Accessories:

<i>Decentralization kit</i> for steel cables		KIT DEC B	27,73
	for steel cables + canopy	KIT DEC F	48,74
	canopy for electrical dec.	KIT DEC M	85,71

Colours: bianco



Special colours on request

Weight:
net kg 3,10

• H. 10 m on demand:
lead times to be checked with the sales department

Halo, Fluo, LED retrofit light bulbs not included
→ specifications p. 190

Decentralization
→ specifications p. 124

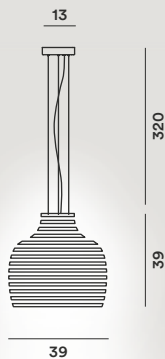

collection →



Birdie

Ludovica + Roberto
Palomba, 2013



Polycarbonate
and metallized steel

Birdie grande
LED retrofit or Fluo 1x25W E27
Halo 1x105W E27

Birdie piccola
LED retrofit or Fluo 1x20W E27
Halo 1x70W E27

Ⓢ CE IP 20

	energy cl.	colours	code	vat excluded
<i>Birdie grande</i>	A ⁺ , A	bianco	221017 10	205,89
		grigio	221017 25	
		arancio	221017 53	
		amaranto	221017 65	
<i>Birdie piccola</i>	A ⁺ , A	bianco	221027 10	176,48
		grigio	221027 25	
		arancio	221027 53	
		amaranto	221027 65	
<i>Birdie grande h. 10 m</i> •	A ⁺ , A	bianco	221017/10-10	260,51
		grigio	221017/10-25	
		arancio	221017/10-53	
		amaranto	221017/10-65	
<i>Birdie piccola h. 10 m</i> •	A ⁺ , A	bianco	221027/10-10	231,10
		grigio	221027/10-25	
		arancio	221027/10-53	
		amaranto	221027/10-65	
Accessories:				
<i>Decentralization kit</i> for power cable			KIT DEC C	32,77
canopy for electrical dec.			KIT DEC M	85,71

Colours: bianco, grigio,
arancio, amaranto



Weight:
Birdie grande
net kg 1,30

Birdie piccola
net kg 1,00

Halo, Fluo, LED retrofit
light bulbs not included
→ specifications p. 190

Decentralization
→ specifications p. 124

•
H. 10 m on demand:
lead times to be
checked with the
sales department

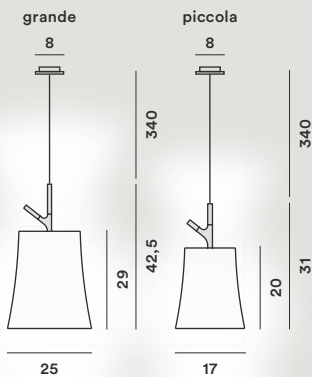

Big Bang

Enrico Franzolini con
Vicente Garcia Jimenez, 2005



Methacrylate and coated
aluminium

Big Bang LED included
37,7 W Mid power 3000° K
3885 lm CRI>90 103 lm/W
Dimmable LED version
Possible configurations:
On-Off/Push/DALI

Big Bang
Halo or LED retrofit
1x160W R7s

Big Bang fluorescent
Fluo 1x26W GX24q-3



	energy cl.	colours	code	vat excluded
Big Bang LED	A ⁺	bianco	151007L 10	1.105,46
		rosso	151007L 63	1.223,11
Big Bang LED dimmable	A ⁺	bianco	151007LD 10	1.191,17
		rosso	151007LD 63	1.308,82
Big Bang	A ⁺ , A, C	bianco	151007 10	661,76
		rosso	151007 63	779,41
Big Bang fluorescent	A ⁺ , A	bianco*	151007F 10	664,70
		rosso*	151007F 63	782,35
Big Bang LED h. 10 m •	A ⁺	bianco	151007L/10-10	1.205,60
		rosso	151007L/10-63	1.323,25
Big Bang LED dimmable h. 10 m •	A ⁺	bianco	151007LD10-10	1.291,31
		rosso	151007LD10-63	1.408,96
Big Bang h. 10 m •	A ⁺ , A, C	bianco	151007 10SP10	761,90
		rosso	151007 63SP10	879,55

Spare parts:

Set lampshades Big Bang	bianco	151S00 10	258,82
	rosso	151S00 63	376,47
Halogen protection glass		PIREX180-50/I	25,21

Accessories:

Decentralization kit for steel cables		KIT DEC B	27,73
	for steel cables + canopy	KIT DEC F	48,74
	canopy for electrical dec.	KIT DEC M	85,71

* limited stock available

Colours: bianco, rosso



Special colours
on request

Weight:
Big Bang LED
net kg 7,40

Big Bang
net kg 5,40

•
H. 10 m on demand:
lead times to be
checked with the
sales department

Halo, Fluo, LED retrofit
light bulbs not included
→ specifications p. 190

Decentralization
→ specifications p. 124

LED and dimming
→ specifications p. 189

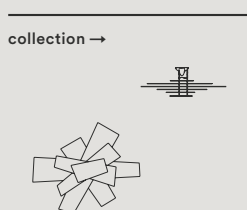
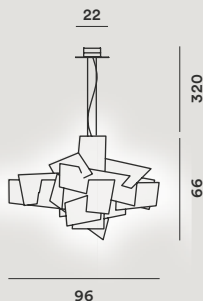

Big Bang L - XL

Enrico Franzolini con
Vicente Garcia Jimenez,
2005-2016



Methacrylate and coated
aluminium

Big Bang L

LED included

58W Mid power 3000° K
6084 lm CRI>90 105 lm/W
Dimmable
Possible configurations:
On-Off/Push/DALI

Big Bang XL

LED included

87W Mid power 3000° K
9126 lm CRI>90 105 lm/W
Dimmable
Possible configurations:
On-Off/Push/DALI

⊕ CE IP 20

LED

	energy cl.	colours	code	vat excluded
<i>Big Bang L</i>	A ⁺	bianco	151017 10	2.168,06
		rosso	151017 63	2.299,15
<i>Big Bang XL</i>	A ⁺	bianco	1510072L 10	3.473,95
		rosso	1510072L 63	4.001,68
<i>Big Bang L h. 10 m •</i>	A ⁺	bianco	151017/10-10	2.245,09
		rosso	151017/10-63	2.376,18
<i>Big Bang XL h. 10 m •</i>	A ⁺	bianco	1510072L/1010	3.550,98
		rosso	1510072L/1063	4.078,71

Spare parts:

<i>Set diffusori Big Bang L</i>	bianco	151S001 10	903,36
	rosso	151S001 63	1.034,45
<i>Set diffusori Big Bang XL</i>	bianco	151S002 10	1.765,55
	rosso	151S002 63	2.293,28

Accessories:

<i>Decentralization kit</i> for steel cables	KIT DEC B	27,73
--	-----------	-------

Colours: bianco, rosso



Special colours
on request

Weight:

Big Bang L
net kg 21,00

Big Bang XL
net kg 35,00

•

H. 10 m on demand:
lead times to be
checked with the
sales department

Halo, Fluo, LED retrofit
light bulbs not included
→ specifications p. 190

Decentralization
→ specifications p. 124

LED and dimming
→ specifications p. 189

Big Bang L

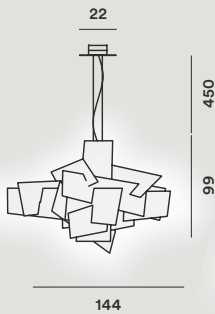

Big Bang XL

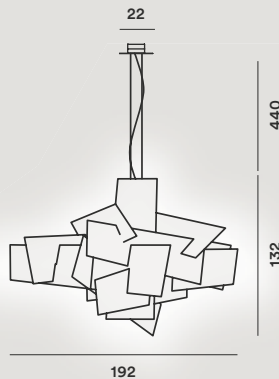

collection →

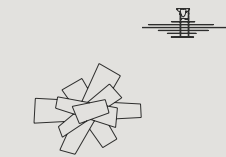

p. 148 p. 129



Buds

Rodolfo Dordoni, 2016



Blown glass

Buds 1-2-3

LED retrofit included
21W E27 2700° K
2500 lm CRI > 80
Dimmable with
TRIAC technology

Buds 1-2-3 LED included
24W COB 2700° K
2676 lm CRI>90 111 lm/W
Dimmable version
Possible configurations:
On-Off/Push/DALI

On request on/off or
dimmable
24W COB 3000° K
3385 lm CRI>80 141 lm/W



	energy cl.	colours	code	vat excluded
Buds 1	A ⁺	bianco caldo	278071E-12	469,74
		marrone	278071E-54	
Buds 2		bianco caldo	278072E-12	503,36
		grigio	278072E-24	
Buds 3		bianco caldo	278073E-12	439,49
		verde	278073E-40	
Buds 1 LED	A ⁺	bianco caldo	278071L 12	639,50
		marrone	278071L 54	
Buds 2 LED		bianco caldo	278072L 12	673,11
		grigio	278072L 24	
Buds 3 LED		bianco caldo	278073L 12	609,25
		verde	278073L 40	
Buds 1 LED dimmable	A ⁺	bianco caldo	278071LD 12	693,28
		marrone	278071LD 54	
Buds 2 LED dimmable		bianco caldo	278072LD 12	726,89
		grigio	278072LD 24	
Buds 3 LED dimmable		bianco caldo	278073LD 12	663,03
		verde	278073LD 40	

Colours:
Buds 1 bianco caldo,
marrone.
Buds 2 bianco caldo,
grigio.
Buds 3 bianco caldo,
verde bambù



Weight:
Buds 1
net kg 3,20

Buds 2
net kg 4,20

Buds 3
net kg 3,20

Buds 1 LED
net kg 3,90

Buds 2 LED
net kg 4,90

Buds 3 LED
net kg 3,90

Fluo, LED retrofit light
bulbs not included
specifications p. 190

LED and dimming
→ specifications p. 189

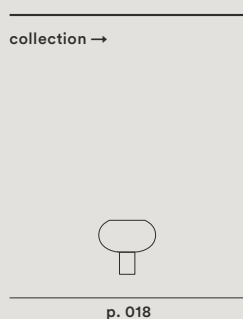
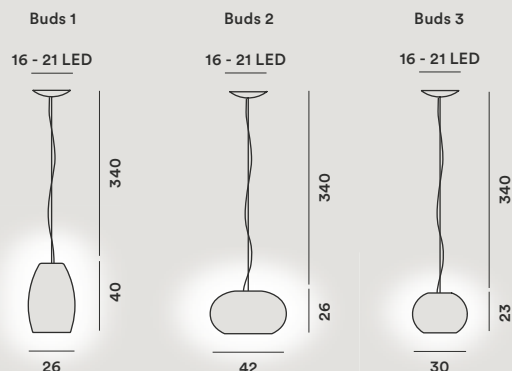

	energy cl.	colours	code	vat excluded
Buds 1 h. 10 m •	A ⁺	bianco caldo	278071E/10-12	509,78
		marrone	278071E/10-54	
Buds 2 h. 10 m •		bianco caldo	278072E/10-12	543,40
		grigio	278072E/10-24	
Buds 3 h. 10 m •		bianco caldo	278073E/10-12	479,53
		verde	278073E/10-40	
Buds 1 LED h. 10 m •	A ⁺	bianco caldo	278071L/10-12	679,56
		marrone	278071L/10-54	
Buds 2 LED h. 10 m •		bianco caldo	278072L/10-12	713,17
		grigio	278072L/10-24	
Buds 3 LED h. 10 m •		bianco caldo	278073L/10-12	649,31
		verde	278073L/10-40	
Buds 1 LED dimmable h. 10 m •	A ⁺	bianco caldo	278071LD/1012	733,32
		marrone	278071LD/1054	
Buds 2 LED dimmable h. 10 m •		bianco caldo	278072LD/1012	766,93
		grigio	278072LD/1024	
Buds 3 LED dimmable h. 10 m •		bianco caldo	278073LD/1012	703,07
		verde	278073LD/1040	

•

H. 10 m on demand:

lead times to be
checked with the sales
department



Caboche grande

Patricia Urquiola
con Eliana Gerotto, 2005



PMMA, blown glass,
chromed metal and
aluminium (LED)

Caboche grande
LED included
46W (36 + 10 Mid-power)
3000°K 4330 lm
CRI>90 94,1 lm/W
Dimmable version
Possible configurations:
On-Off/Push/DALI

Caboche grande
LED retrofit or Halo
1x230W R7s



	energy cl.	colours	code	vat excluded
<i>Caboche grande LED</i>	A ⁺	trasparente	138017L 16	2.155,46
		giallo oro	138017L 52	
<i>Caboche grande LED dimmable</i>	A ⁺	trasparente	138017LD 16	2.239,50
		giallo oro	138017LD 52	
<i>Caboche grande</i>	A ⁺ , A, C	trasparente	138017 16	1.533,62
		giallo oro	138017 52	
<i>Caboche grande LED h. 10 m •</i>	A ⁺	trasparente	138017L/10-16	2.392,15
		giallo oro	138017L/10-52	
<i>Caboche grande LED dimmable h. 10 m •</i>	A ⁺	trasparente	138017LD/1016	2.476,20
		giallo oro	138017LD/1052	
<i>Caboche grande h. 10 m •</i>	A ⁺ , A, C	trasparente	138017/10-16	1.770,32
		giallo oro	138017/10-52	

Spare parts:

<i>Kit 10 spheres Caboche</i>	trasparente	138KIT 10SF16	39,50
	giallo oro	138KIT 10SF52	
<i>Kit 20 prongs 4 spheres Caboche</i>		138KIT 20G4	36,97
<i>Kit 20 prongs 5 spheres Caboche</i>		138KIT 20G5	36,97
<i>Kit 3+3 prongs 4-5 spheres Caboche</i>		138KIT1-R2	20,17
<i>Inner glass Caboche LED</i>		138V0118/I	118,49
<i>Inner glass Caboche halogen</i>		138V011/I	120,17
<i>Halogen protection glass</i>		PIREX138/2S4I	20,17
<i>Halogen protection disk Caboche</i>		138V021/I	48,74

Accessories:

<i>Decentralization kit for steel cables</i>		KIT DEC B	27,73
	for steel cables + canopy	KIT DEC F	48,74
	canopy for electrical dec.	KIT DEC M	85,71

Colours: bianco, giallo oro

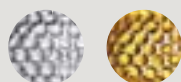

Special colours
on request

Weight:
Caboche grande
LED
net kg 17,00

Caboche grande
net kg 19,60

•
H. 10 m on demand:
lead times to be
checked with the
sales department

Halo, LED retrofit
light bulbs not included
→ specifications p. 190

Decentralization
→ specifications p. 124

LED and dimming
→ specifications p. 189

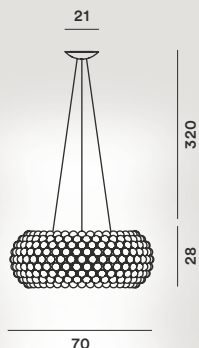

collection →

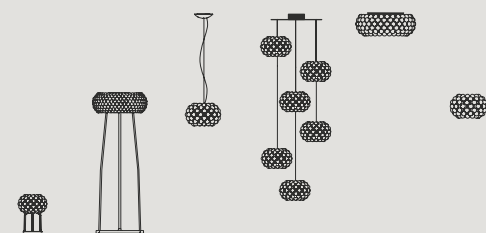

p. 019 p. 044 p. 077-078 p. 116 p. 133 p. 152

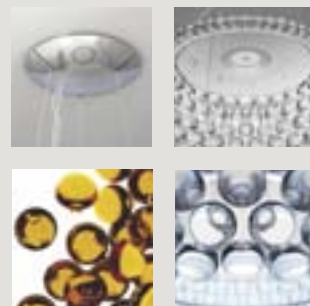

Caboche media

Patricia Urquiola
con Eliana Gerotto, 2005



PMMA, blown glass,
chromed metal and
aluminium (LED)

Caboche media
LED included
35W (28 + 7Mid power)
3000°K 3665 lm
CRI > 90 104,4 lm/W
Dimmable version
Possible configurations:
On-Off/Push/DALI

Caboche media
LED retrofit or Halo
1x160W R7s



	energy cl.	colours	code	vat excluded
<i>Caboche media LED</i>	A ⁺	trasparente	138007L 16	1.188,66
		giallo oro	138007L 52	
<i>Caboche media LED dimmable</i>	A ⁺	trasparente	138007LD 16	1.272,69
		giallo oro	138007LD 52	
<i>Caboche media</i>	A ⁺ , C	trasparente	138007 16	860,93
		giallo oro	138007 52	
<i>Caboche media LED h. 10 m •</i>	A ⁺	trasparente	138007L/10-16	1.277,86
		giallo oro	138007L/10-52	
<i>Caboche media LED dimmable h. 10 m •</i>	A ⁺	trasparente	138007LD/1016	1.361,91
		giallo oro	138007LD/1052	
<i>Caboche media h. 10 m •</i>	A ⁺ , C	trasparente	138007/10-16	1.001,13
		giallo oro	138007/10-52	

Spare parts:

<i>Kit 10 spheres Caboche</i>	trasparente	138KIT 10SF16	39,50
	giallo oro	138KIT 10SF52	
<i>Kit 15 prongs 3 spheres Caboche</i>		138KIT 15M3	29,41
<i>Kit 15 prongs 4 spheres Caboche</i>		138KIT 15M4	29,41
<i>Kit 3+3 prongs 3-4 spheres Caboche</i>		138KIT-R2	21,01
<i>Inner glass Caboche halogen</i>		138V01R1/I	79,83
<i>Inner glass Caboche LED</i>		138V018/I	90,76
<i>Halogen protection glass</i>		PIREX138/2S4I	20,17
<i>Disco protezione halogen</i>		138V02/I	36,97

Accessories:

<i>Decentralization kit</i> for steel cables		KIT DEC B	27,73
	for steel cables + canopy	KIT DEC F	

Colours: bianco, giallo oro

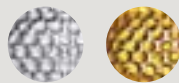

Special colours
on request

Weight:
Caboche media
LED
net kg 10,20

Caboche media
net kg 10,20

•
H. 10 m on demand:
lead times to be
checked with the
sales department

Halo, LED retrofit light bulbs
not included
→ specifications p. 190

Decentralization
→ specifications p. 124

LED and dimming
→ specifications p. 189

16 - 21 LED

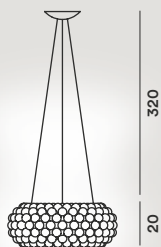

50

collection →

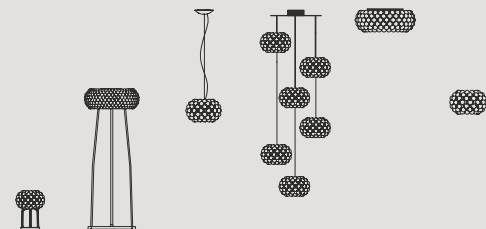

p. 019

p. 044

p. 076-078

p. 116

p. 133

p. 152



Caboche piccola

Patricia Urquiola
con Eliana Gerotto, 2005



PMMA, blown glass and
chromed metal

LED retrofit or Halo
1x60W G9

⊕ CE IP 20

	energy cl.	colours	code	vat excluded
<i>Caboche piccola</i>	A ⁺ , A, C	trasparente	138027 16	428,57
		giallo oro	138027 52	
<i>Caboche piccola h. 10 m</i> •	A ⁺ , A, C	trasparente	138027/10-16	537,81
		giallo oro	138027/10-52	

Spare parts:

<i>Kit 10 spheres Caboche</i>	trasparente	138KIT 10SF16	39,50
	giallo oro	138KIT 10SF52	
<i>Kit 10 prongs 3 spheres Caboche</i>		138KIT 10P3	24,37
<i>Kit 10 prongs 4 spheres Caboche</i>		138KIT 10P4	24,37
<i>Kit 3+3 prongs 3-4 spheres Caboche</i>		138KIT2-R2	17,65
<i>Inner glass Caboche piccola</i>		138V012/I	42,02

Accessories:

<i>Decentralization kit</i> for steel cables		KIT DEC B	27,73
	for steel cables + canopy	KIT DEC F	
	canopy for electrical dec.	KIT DEC M	

Colours: bianco, giallo oro

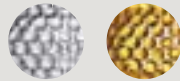

Special colours
on request

Weight:
net kg 4,80

• **H. 10 m on demand:**
lead times to be
checked with the
sales department

Halo, LED retrofit light
bulbs not included
→ specifications p. 190

Multiple canopy
→ specifications p. 116

Decentralization
→ specifications p. 124

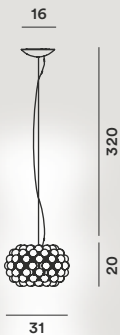

collection →

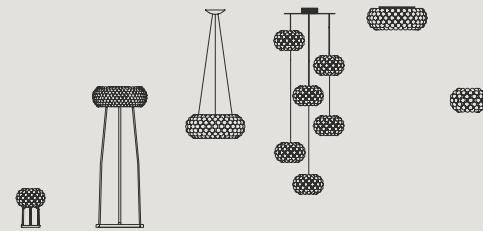

p. 019 p. 044 p. 076-077 p. 116 p. 133 p. 152



Caiigo

Marco Zito, 2016



Blown glass and aluminium

LED retrofit
1x8W GU10 PAR 16

	energy cl.	colours	code	vat excluded	
<i>Caiigo</i>	A ⁺ , A, C	bianco	266007R1-15	418,07	
<i>Caiigo h. 10 m •</i>	A ⁺ , A, C	bianco	266007R1/1015	481,79	
Spare parts:					
<i>Lampshade Caiigo</i>		bianco	266S00 15	243,70	
Accessories:					
<i>Decentralization kit</i> for steel cables			KIT DEC B	27,73	
			for steel cables + canopy	KIT DEC F	48,74
			canopy for electrical dec.	KIT DEC M	85,71

Colours: bianco sfumato

Weight:
net kg 2,00

- **H. 10 m on demand:**
lead times to be
checked with the
sales department

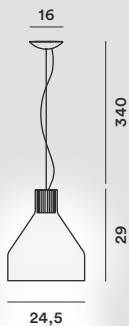
LED retrofit light bulbs
not included
→ specifications p. 190Multiple canopy
→ specifications p. 116Decentralization
→ specifications p. 124

Chouchin

Ionna Vautrin, 2011



Lacquered blown glass

Chouchin

LED retrofit included
21W E27 2700° K
2500 lm CRI > 80
Dimmable with
TRIAC technology

Chouchin LED included
24W COB 2700° K
2676 lm CRI>90 111 lm/W
Dimmable LED version
Possible configurations:
On-Off/Push/DALI

On request on/off or
dimmable
24W COB 3000° K
3385 lm CRI > 80 141 lm/W



	energy cl.	colours	code	vat excluded
<i>Chouchin 1</i>	A ⁺	arancio	210071E-53	435,29
<i>Chouchin 2</i>		verde	210072E-40	405,88
<i>Chouchin 3</i>		grigio	210073E-25	347,05
<i>Chouchin 1 LED</i>	A ⁺	arancio	210071L 53	544,54
<i>Chouchin 2 LED</i>		verde	210072L 40	515,13
<i>Chouchin 3 LED</i>		grigio	210073L 25	456,30
<i>Chouchin 1 LED dimmable</i>	A ⁺	arancio	210071LD 53	598,32
<i>Chouchin 2 LED dimmable</i>		verde	210072LD 40	568,91
<i>Chouchin 3 LED dimmable</i>		grigio	210073LD 25	510,08
<i>Chouchin 1 h. 10 m •</i>	A ⁺	arancio	210071E/10-53	475,33
<i>Chouchin 2 h. 10 m •</i>		verde	210072E/10-40	445,92
<i>Chouchin 3 h. 10 m •</i>		grigio	210073E/10-25	387,09
<i>Chouchin 1 LED h. 10 m •</i>	A ⁺	arancio	210071L/10-53	584,60
<i>Chouchin 2 LED h. 10 m •</i>		verde	210072L/10-40	555,19
<i>Chouchin 3 LED h. 10 m •</i>		grigio	210073L/10-25	496,36
<i>Chouchin 1 LED dimm. h. 10 m •</i>	A ⁺	arancio	210071LD/1053	638,36
<i>Chouchin 2 LED dimm. h. 10 m •</i>		verde	210072LD/1040	608,95
<i>Chouchin 3 LED dimm. h. 10 m •</i>		grigio	210073LD/1025	550,12

Spare parts:

<i>Glass Chouchin 1</i>	arancio	210S001R1 53	300,00
<i>Glass Chouchin 2</i>	verde	210S002R1 40	270,59
<i>Glass Chouchin 3</i>	grigio	210S003R1 25	211,76

Accessories:

<i>Decentralization kit</i> for steel cables	KIT DEC B	27,73
for steel cables + canopy	KIT DEC F	48,74
canopy for electrical dec.	KIT DEC M	85,71

Colours:

Chouchin 1 arancio,
Chouchin 2 verde,
Chouchin 3 grigio



Special colours
on request

Weight:

Chouchin 1
net kg 4,40

Chouchin 2
net kg 2,90

Chouchin 3
net kg 3,60

Chouchin 1 LED
net kg 5,00

Chouchin 2 LED
net kg 3,50

Chouchin 3 LED
net kg 4,20

Multiple canopy

→ specifications p. 116

Decentralization

→ specifications p. 124

LED and dimming

→ specifications p. 189

• **H. 10 m on demand:**
lead times to be
checked with the sales
department

Chouchin 1
12 - 21 LED



Chouchin 2
12 - 21 LED

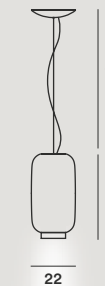

Chouchin 3
12 - 21 LED

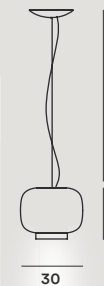

collection →

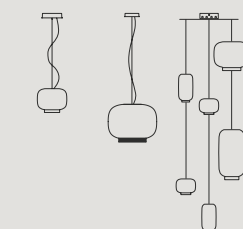

p. 081

p. 082

p. 116



Chouchin mini

Ionna Vautrin, 2013



Lacquered blown glass

LED retrofit
1x8W GU10 PAR 16

⊕ CE IP 20

	energy cl.	colours	code	vat excluded
<i>Chouchin mini 1</i>	A ⁺ , A, C	arancio	210271R1-53	223,11
<i>Chouchin mini 2</i>	A ⁺ , A, C	verde	210272R1-40	244,96
<i>Chouchin mini 1 h. 10 m</i> •	A ⁺ , A, C	arancio	210271R1/1053	264,97
<i>Chouchin mini 2 h. 10 m</i> •	A ⁺ , A, C	verde	210272R1/1040	286,84

Spare parts:

<i>Glass Chouchin mini 1</i>	arancio	210S021 53	117,65
<i>Glass Chouchin mini 2</i>	verde	210S022 40	117,65

Accessories:

<i>Decentralization kit</i> for steel cables	KIT DEC B	27,73
for steel cables + canopy	KIT DEC F	48,74
canopy for electrical dec.	KIT DEC M	85,71

Colours:

Chouchin mini 1 arancio,
Chouchin mini 2 verde



Special colours
on request

Weight:

Chouchin mini 1
net kg 1,00

Chouchin mini 2
net kg 1,10

•
H. 10 m on demand:
lead times to be
checked with the
sales department

LED retrofit light bulbs
not included
→ specifications p. 190

Multiple canopy
→ specifications p. 116

Decentralization
→ specifications p. 124

mini 1

mini 2

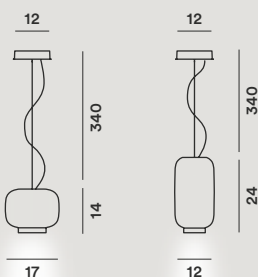

collection →

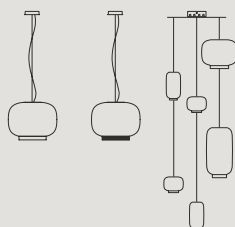

p. 080

p. 082

p. 116



Chouchin reverse

Ionna Vautrin, 2015



Lacquered blown glass

Chouchin

LED retrofit included
21W E27 2700° K
2500 lm CRI > 80
Dimmable with TRIAC technology

Chouchin LED included
24W COB 2700° K
2676 lm CRI>90 111 lm/W
Dimmable LED version
Possible configurations:
On-Off/Push/DALI

On request on/off or dimmable
24W COB 3000° K
3385 lm CRI > 80 141 lm/W



	energy cl.	colours	code	vat excluded
Chouchin 1 reverse	A ⁺	bianco/arancio	210071E-05	435,29
Chouchin 2 reverse		bianco/verde	210072E-04	405,88
Chouchin 3 reverse		bianco/grigio	210073E-02	347,05
Chouchin 1 reverse LED	A ⁺	bianco/arancio	210071L 05	544,54
Chouchin 2 reverse LED		bianco/verde	210072L 04	515,13
Chouchin 3 reverse LED		bianco/grigio	210073L 02	456,30
Chouchin 1 rev. LED dimm.	A ⁺	bianco/arancio	210071LD 05	598,32
Chouchin 2 rev. LED dimm.		bianco/verde	210072LD 04	568,91
Chouchin 3 rev. LED dimm.		bianco/grigio	210073LD 02	510,08

Colours:
Chouchin reverse 1
bianco / arancio
Chouchin reverse 2
bianco / verde
Chouchin reverse 3
bianco / grigio

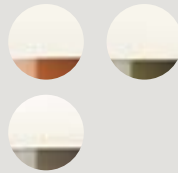

Special colours on request

Weight:
Chouchin reverse 1
net kg 4,40

Chouchin reverse 2
net kg 2,90

Chouchin reverse 3
net kg 3,60

Chouchin reverse 1 LED LED and dimming
net kg 5,00

Chouchin reverse 2 LED
net kg 3,50

Chouchin reverse 3 LED
net kg 4,20

Halo, Fluo, LED retrofit light bulbs not included
→ specifications p. 190

Multiple canopy
→ specifications p. 116

Decentralization
→ specifications p. 124

LED and dimming
→ specifications p. 189

Tecnico — 2018

Chouchin 1

12 - 21 LED

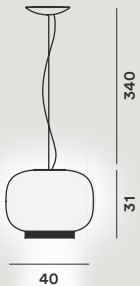

Chouchin 2

12 - 21 LED

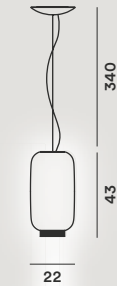

Chouchin 3

12 - 21 LED

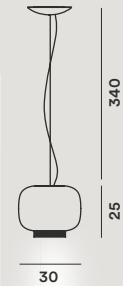

collection →

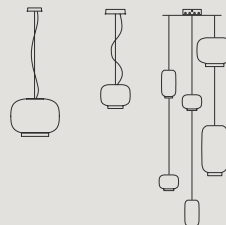

p. 080

p. 081

p. 116

	energy cl.	colours	code	vat excluded
<i>Chouchin 1 rev. h. 10 m •</i>	A ⁺	bianco/arancio	210071E/10-05	475,33
<i>Chouchin 2 rev. h. 10 m •</i>		bianco/verde	210072E/10-04	445,92
<i>Chouchin 3 rev. h. 10 m •</i>		bianco/grigio	210073E/10-02	387,09
<i>Chouchin 1 rev. LED h. 10 m •</i>	A ⁺	bianco/arancio	210071L/10-05	584,60
<i>Chouchin 2 rev. LED h. 10 m •</i>		bianco/verde	210072L/10-04	555,19
<i>Chouchin 3 rev. LED h. 10 m •</i>		bianco/grigio	210073L/10-02	496,36
<i>Chouchin 1 rev. LED dimm. h. 10 m • A⁺</i>		bianco/arancio	210071LD/1005	638,36
<i>Chouchin 2 rev. LED dimm. h. 10 m •</i>		bianco/verde	210072LD/1004	608,95
<i>Chouchin 3 rev. LED dimm. h. 10 m •</i>		bianco/grigio	210073LD/1002	550,12
Spare parts:				
<i>Glass Chouchin 1 reverse</i>		bianco/arancio	210S001R1 05	300,00
<i>Glass Chouchin 2 reverse</i>		bianco/verde	210S002R1 04	270,59
<i>Glass Chouchin 3 reverse</i>		bianco/grigio	210S003R1 02	211,76
Accessories:				
<i>Decentralization kit</i> for steel cables			KIT DEC B	27,73
			for steel cables + canopy	48,74
			canopy for electrical dec.	85,71

•
H. 10 m on demand:
 lead times to be checked
 with the sales department



Chouchin 1

Chouchin 2

Chouchin 3

Dolmen

Ferruccio Laviani,
1996/2017



	energy cl.	colours	code	vat excluded
<i>Dolmen</i>	A ⁺	alluminio	280007-25	1.344,54
		arancio	280007-14	1.487,39
		bronzo	280007-73	1.487,39
<i>Dolmen h. 10 m •</i>	A ⁺	alluminio	280007/10-25	1.566,67
		arancio	280007/10-14	1.709,56
		bronzo	280007/10-73	1.709,56

Varnished or anodised aluminium
LED included
47W 2700°K 6486 lm
CRI>90 138 lm/W
Dimmable
Possible configurations:
On-Off/Push/DALI
⊕ CE IP 20

Colours:
alluminio, arancione,
bronzo



Weight:
net kg 12,50

LED and dimming
→ specifications p. 189

•
H. 10 m on demand:
lead times to be
checked with the
sales department

Tecnico — 2018

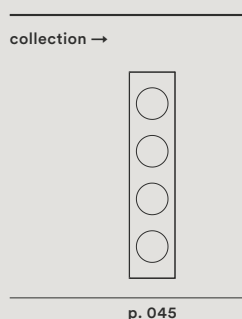
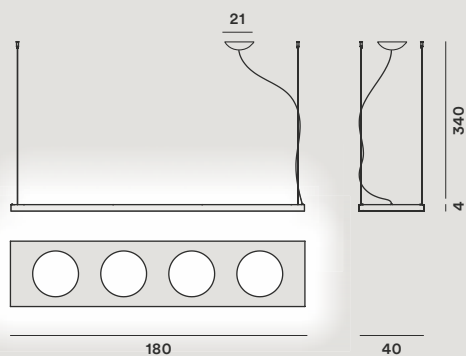

Gem

Ludovica + Roberto
Palomba, 2017



Blown acid-etched glass
with reliefs

Gem E27
LED retrofit / Fluo
1x25W E27
Halo 1x150W E27

Gem LED
included 24W COB 2700° K
2676 lm CRI>90 111 lm/W
Dimmable version
Possible configurations:
On-Off/Push/DALI

On request on/off or
dimmable
24W COB 3000° K
3385 lm CRI > 80 141 lm/W

⊕ CE IP 20



	energy cl.	colours	code	vat excluded
Gem E27	A+, A	bianco	274007-10	419,33
Gem LED	A+	bianco	274007L-10	483,20
Gem LED dimmable	A+	bianco	274007LD-10	536,98
Gem E27 h. 10 m •	A+, A	bianco	274007/10-10	459,37
Gem LED h. 10 m •	A+	bianco	274007L/10-10	523,26
Gem LED dimm. h. 10 m •	A+	bianco	274007LD/1010	577,02

Spare parts:

Glass Gem	bianco	274S007-10	238,66
------------------	--------	------------	--------

Accessories:

Decentralization kit for steel cables	KIT DEC B	27,73
for steel cables + canopy	KIT DEC F	48,74
canopy for electrical dec.	KIT DEC M	85,71

Colours: bianco



Weight:
net kg 4,60

•
H. 10 m on demand:
lead times to be
checked with the
sales department

Halo, Fluo, LED retrofit
light bulbs not included

LED and dimming
→ specifications p. 189

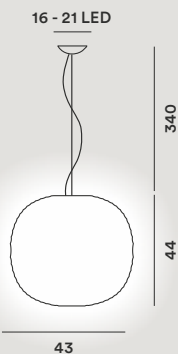

collection →

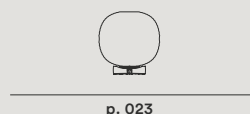

Gregg

Ludovica + Roberto
Palomba, 2007



	energy cl.	colours	code	vat excluded
<i>Gregg grande</i>	A ⁺ , A	bianco	1680071 10	484,04
<i>Gregg media</i>	A ⁺	bianco	168007E-10	306,72
<i>Gregg midi</i>	A ⁺	bianco	1680073-10	277,32
<i>Gregg piccola</i>	A ⁺ , A, C	bianco	1680072R1-10	156,31
<i>Gregg media LED</i>	A ⁺	bianco	168007L 10	415,97
<i>Gregg media LED dimmable</i>	A ⁺	bianco	168007LD 10	469,75
<i>Gregg grande LED</i>	A ⁺	bianco	1680071L 10	562,19
<i>Gregg grande LED dimmable</i>	A ⁺	bianco	1680071LD 10	615,97

Blown acid-etched glass

Gregg grande
LED retrofit o Fluo
1x30W E27
Halo 1x205W E27

Gregg media
LED retrofit included
21W E27 2700° K
2500 lm CRI > 80
Dimmable with
TRIAC technology

Gregg midi
LED included COB 8,5W
2700° K 700 lm CRI>90
Dimmable with
TRIAC technology

Gregg piccola
LED retrofit 1x3,5W G9
Halo 1x33W G9

Gregg grande/media LED
LED included
24W COB 2700° K
2676 lm CRI>90 111 lm/W
Dimmable version
Possible configurations:
On-Off/Push/DALI

On request on/off or
dimmable
24W COB 3000° K
3385 lm CRI>80 141 lm/W



Colours: bianco



Weight:

Gregg grande
net kg 5,60

Gregg media
net kg 3,20

Gregg midi
net kg 1,60

Gregg piccola
net kg 0,70

Gregg grande LED
net kg 6,20

Gregg media LED
net kg 3,80

Halo, Fluo, LED retrofit
light bulbs not included
→ specifications p. 190

Multiple canopy
→ specifications p. 116

Decentralization
→ specifications p. 124

LED and dimming
→ specifications p. 189

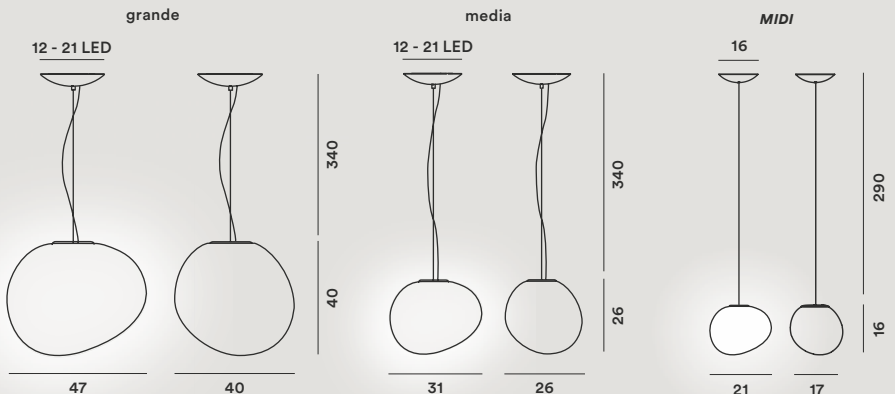

	energy cl.	colours	code	vat excluded
<i>Gregg grande h. 10 m •</i>	A ⁺ , A	bianco	1680071/10-10	578,72
<i>Gregg media h. 10 m •</i>	A ⁺	bianco	168007E/10-10	346,76
<i>Gregg midi h. 10 m •</i>	A ⁺	bianco	1680073/10-10	302,95
<i>Gregg piccola h. 10 m •</i>	A ⁺ , A, C	bianco	1680072R1010	221,85
<i>Gregg media LED h. 10 m •</i>	A ⁺	bianco	168007L/10-10	456,03
<i>Gregg media LED h. 10 m dimm. •</i>	A ⁺	bianco	168007LD/1010	509,79
<i>Gregg grande LEDh. 10 m •</i>	A ⁺	bianco	1680071L/1010	602,25
<i>Gregg grande LED h. 10 m dimm. •</i>	A ⁺	bianco	1680071LD1010	656,01

Spare parts:

<i>Glass Gregg grande</i>	bianco	168S001 10	317,65
<i>Glass Gregg media</i>	bianco	168S007R1 10	171,43
<i>Glass Gregg midi</i>	bianco	168RV003-10	89,29
<i>Glass Gregg piccola</i>	bianco	168S00210	58,82

Accessories:

<i>Decentralization kit</i>	for steel cables	KIT DEC B	27,73
<i>Gregg grande/media</i>	for steel cables + canopy	KIT DEC F	48,74
<i>Gregg piccola</i>	for power cable	KIT DEC C	32,77
	canopy for electrical dec.	KIT DEC M	85,71

•
H. 10 m on demand:
 lead times to be checked
 with the sales department

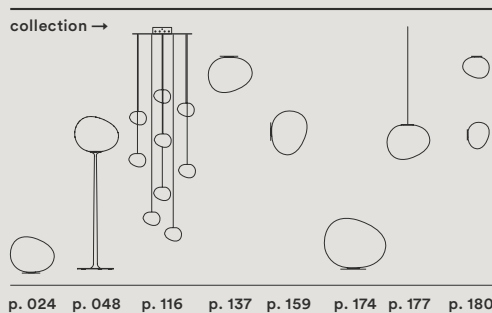
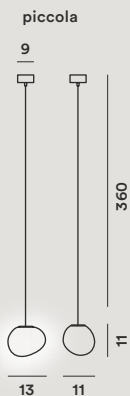

Giga-Lite

Marc Sadler, 2004



Fiberglass fabric with carbonium thread, steel and nickel-plated metal

LED retrofit or Fluo
3x20W E27
Halo 3x77W E27

⊕ CE IP 20

	energy cl.	colours	code	vat excluded
<i>Giga-Lite</i>	A ⁺ , A	nero	139017 20	685,72
<i>Giga-Lite h. 10 m</i> ●	A ⁺ , A	nero	139017/10-20	758,54

Spare parts:

<i>Lampshade Giga-Lite</i>	nero	139S001 20	371,43
----------------------------	------	------------	--------

Accessories:

<i>Decentralization kit</i> for power cable		KIT DEC C	32,77
	canopy for electrical dec.	KIT DEC M	85,71

Colours: nero



Weight:
net kg 2,50

Halo, Fluo, LED retrofit
light bulbs not included
→ specifications p. 190

●
H. 10 m on demand:
lead times to be
checked with the
sales department

Decentralization
→ specifications p. 124

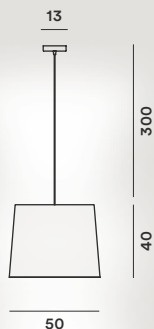

collection →

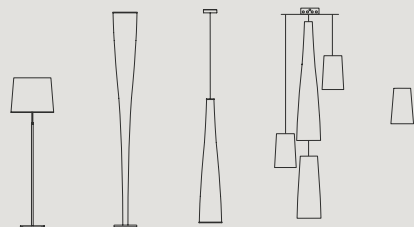

p. 047 p. 053 p. 105 p. 116 p. 152



Havana

Joseph Forakis, 1993



Injection moulded polyethylene and coated metal

LED retrofit or Fluo
1x25W E27
Halo 1x105W E27

⊕ CE IP 20

Havana doppia, tripla, quadrupla

⊕ CE IP 20

doppia tripla quadrupla

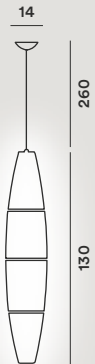
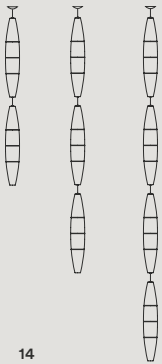

23

	energy cl.	colours	code	vat excluded
<i>Havana</i>	A ⁺ , A	bianco	0400072-R1 10	216,81
<i>Havana h. 10 m •</i>	A ⁺ , A	bianco	0400072/10-10	289,63
<i>Havana doppia</i>	A ⁺ , A	bianco	0400072SP2 10	910,08
<i>Havana tripla</i>	A ⁺ , A	bianco	0400072SP3 10	1.320,16
<i>Havana quadrupla</i>	A ⁺ , A	bianco	0400072SP4 10	1.730,24

Spare parts:

<i>Set lampshades Havana</i>	bianco	040S00 10	78,99
------------------------------	--------	-----------	-------

Accessories:

<i>Decentralization kit</i> for power cable		KIT DEC C	32,77
	canopy for electrical dec.	KIT DEC M	85,71

Colours: bianco



Special colours on request

Weight:
net kg 1,90

• H. 10 m on demand:
lead times to be checked with the sales department

Halo, Fluo, LED retrofit light bulbs not included
→ specifications p. 190

Multiple canopy
→ specifications p. 116

Decentralization
→ specifications p. 124

collection →

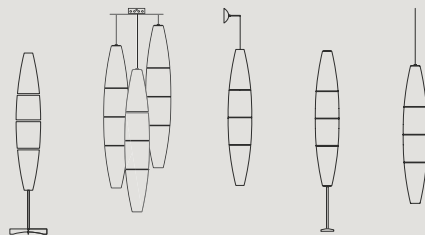

p. 049

p. 116

p. 160

p. 176

p. 178

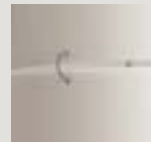

Jamaica

Marc Sadler, 2011



	energy cl.	colours	code	vat excluded
<i>Jamaica</i>	A ⁺ , A	bianco	225007 10	1.131,09
<i>Jamaica dimmable</i>	A ⁺ , A	bianco	225007DM 10	1.236,14
<i>Jamaica h. 10 m •</i>	A ⁺ , A	bianco	225007/10-10	1.243,97
<i>Jamaica dimm. h. 10 m. •</i>	A ⁺ , A	bianco	225007DM/1010	1.349,02

Spare parts:

<i>Set lampshades Jamaica</i>	bianco	225S00 10	545,38
-------------------------------	--------	-----------	--------

Accessories:

<i>Decentralization kit</i> canopy for electrical dec.		KIT DEC M	85,71
--	--	-----------	-------

Paper tape coupled with techno polymer, PMMA and coated metal

Fluo 2x80W max. G5

Multiwatt ballast 35/49/80

Dimmable version
Possible configurations:
On-Off/Push/DALI

⊕ CE IP 20

Colours: bianco



Weight:
net kg 6,00

- H. 10 m on demand:
lead times to be checked with the sales department

Fluo light bulbs
not included
→ specifications p. 190

Decentralization
→ specifications p. 124

LED and dimming
→ specifications p. 189

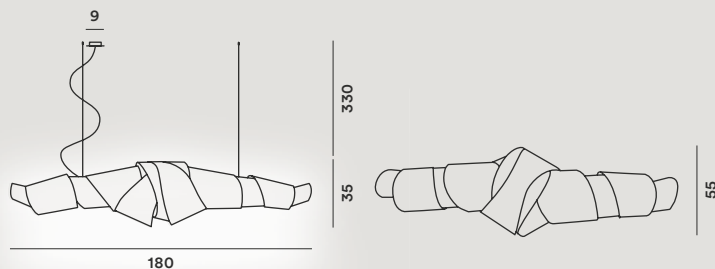

Le Soleil

Vincente Garcia Jimenez,
2009

LED



Injection moulded
polycarbonate and coated
metal

Le Soleil
LED retrofit o Fluo
3x25W E27
Halo 3x70W E27 +
LED retrofit 1x8W GU10 PAR 16

Le Soleil LED included
46W 2700°K
4655 lm CRI>90
dimnable

Possible configurations:
On-Off/Push/DALI

⊕ CE IP 20

	energy cl.	colours	code	vat excluded
<i>Le Soleil</i>	A ⁺ , A	bianco	181007 10	529,42
		rosso	181007 63	739,50
		bronzo	181007-73	
		rame	181007-80	
<i>Le Soleil LED</i>	A ⁺	bianco	181007L-10	554,63
		rosso	181007L-63	764,71
		bronzo	181007L-73	
		rame	181007L-80	
<i>Le Soleil LED dimmable</i>	A ⁺	bianco	181007LD-10	638,66
		rosso	181007LD-63	848,74
		bronzo	181007LD-73	
		rame	181007LD-80	
<i>Le Soleil h. 10 m •</i>	A ⁺ , A	bianco	181007/10-10	602,24
		rosso	181007/10-63	812,32
		bronzo	181007/10-73	
		rame	181007/10-80	
<i>Le Soleil LED h. 10 m •</i>	A ⁺	bianco	181007L/10-10	627,45
		rosso	181007L/10-63	837,53
		bronzo	181007L/10-73	
		rame	181007L/10-80	
<i>Le Soleil LED dimmable h. 10 m •</i>	A ⁺	bianco	181007LD/1010	711,50
		rosso	181007LD/1063	921,58
		bronzo	181007LD/1073	
		rame	181007LD/1080	
Accessories:				
<i>Decentralization kit</i> for steel cables			KIT DEC B	27,73
for steel cables + canopy			KIT DEC F	48,74
canopy for electrical dec.			KIT DEC M	85,71

Colours: bianco, rosso,
rame, bronzo

Weight:
net kg 5,30

Halo, Fluo, LED retrofit
light bulbs not included
→ specifications p. 190



•
H. 10 m on demand:
lead times to be
checked with the
sales department

Decentralization
→ specifications p. 124

LED and dimming
→ specifications p. 189

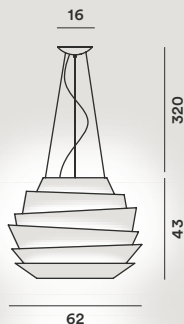

collection →



p. 164

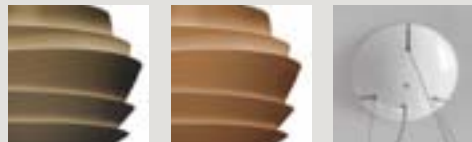

Lightweight

Tom Dixon, 1995



	energy cl.	colours	code	vat excluded
<i>Lightweight</i>	A ⁺ , A, C	anodizzato	064007-R1 ZI	3.151,26
<i>Lightweight h. 10 m •</i>	A ⁺ , A, C	anodizzato	064007-R1/10Z	3.447,05
Spare parts:				
<i>Glass</i>		bianco	061V01/I	22,69
Accessories:				
<i>Decentralization kit</i> for steel cables			KIT DEC B	27,73

Anodized metal

Halo 8x20W G4 12V
LED retrofit 8x2W G4 12V

⊕ Ⓒ IP 20

Colours: anodizzato



Weight:
net kg 7,60

Halo, LED retrofit
light bulbs
not included
→ specifications p. 190

•
H. 10 m on demand:
lead times to be
checked with the
sales department

Tecnico — 2018

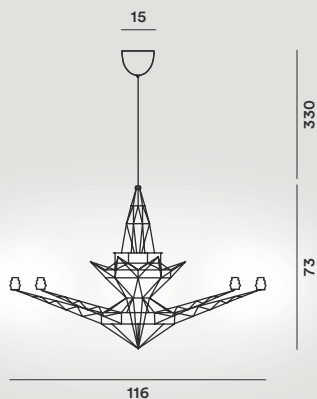

Maki

Nendo, 2011



Lacquered aluminium

LED retrofit
1x8W GU10 PAR 16

IP 20

	energy cl.	colours	code	vat excluded
Maki	A ⁺ , A, C	bianco	219007R1-10	240,34
		grigio	219007R1-25	
Maki h. 10 m •	A ⁺ , A, C	bianco	219007R1/101C	298,60
		grigio	219007R1/102C	
Accessories:				
Decentralization kit for power cable			KIT DEC C	32,77
canopy for electrical dec.			KIT DEC M	85,71

Colours: bianco, grigio

Special colours
on requestWeight:
net kg 0,50

•
H. 10 m on demand:
lead times to be
checked with the
sales department

LED retrofit light
bulbs not included
→ specifications p. 190Multiple canopy
→ specifications p. 116Decentralization
→ specifications p. 124

collection →



p. 116

Bianco



Grigio



O-Space

Luca Nichetto
e Gianpietro Gai, 2003



Expanded polyurethane and
chrome metal

LED retrofit or Halo
1x120W R7s

⊕ CE IP 20

	energy cl.	colours	code	vat excluded
O-Space	A+, A, C	bianco	127007 10	697,48
O-Space h. 10 m •	A+, A, C	bianco	127007 10/SP1	836,41

Spare parts:

Protection glass	bianco	PIREX94/3/I	21,01
Protection disk		PIREX D100/3I	30,25

Accessories:

Decentralization kit for steel cables		KIT DEC B	27,73
for steel cables + canopy		KIT DEC F	48,74
canopy for electrical dec.		KIT DEC M	85,71

Colours: bianco



Weight:
net kg 4,40

•
H. 10 m on demand:
lead times to be
checked with the
sales department

Halo, LED retrofit
light bulbs
not included
→ specifications p. 190

Decentralization
→ specifications p. 124

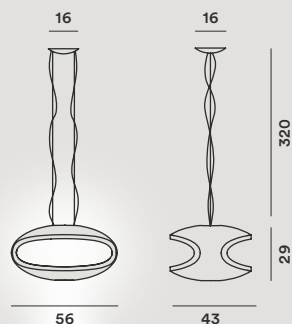

Planet

Changedesign, 2011



	energy cl.	colours	code	vat excluded
<i>Planet grande</i>	A ⁺ , A	bianco*	223017 10	1.006,72
<i>Planet piccola</i>	A ⁺ , A	bianco*	223007 10	686,55

Spare parts:

<i>Lampshade Planet grande</i>	bianco	223S001-R1 10	655,46
<i>Lampshade Planet piccola</i>	bianco	223S00 10	335,29

Accessories:

<i>Decentralization kit</i> for steel cables		KIT DEC B	27,73
	for steel cables + canopy	KIT DEC F	48,74
	canopy for electrical dec.	KIT DEC M	85,71

* Limited stock available

Polyethylene terephthalate
and nylon

Planet grande
LED retrofit or Fluo
1x25W E27
Halo 1x150W E27

Planet piccola
LED retrofit or Fluo
1x25WE27
Halo 1x105W E27

⊕ CE IP 20

Colours: bianco*

* Limited stock available



Weight:
Planet grande
net kg 2,50

Planet piccola
net kg 2,00

Halo, Fluo, LED retrofit
light bulbs not included
→ specifications p. 190

Decentralization
→ specifications p. 124

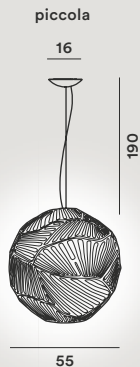
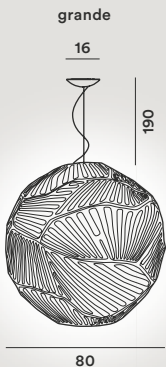

Plass grande

Luca Nichetto, 2011



Rotational moulded polycarbonate and aluminium

LED included
30W Lite-on 3000° K
2500 lm CRI>80 84 lm/W
+ 1x9,5W 2700° K 650 lm
E27 PAR 30"

Plass
Halo or LED retrofit
6x60W G9
+ 1x100W E27 PAR 30 or
1x9,5W E27 PAR

Double switch



	energy cl.	colours	code	vat excluded
<i>Plass grande LED</i>	A ⁺ , A	grigio	2240071L 25	2.672,27
		azzurro	2240071L 30	
<i>Plass grande</i>	A ⁺ , A, C	grigio	2240071 25	2.252,10
		azzurro	2240071 30	
<i>Plass grande LED h. 10 m</i> • A ⁺ , A		grigio	2240071L/1025	2.747,27
		azzurro	2240071L/1030	
<i>Plass grande h. 10 m</i> •	A ⁺ , A, C	grigio	2240071/10-25	2.315,12
		azzurro	2240071/10-30	

Spare parts:

<i>Lampshade Plass</i>	grigio	224S001 25	1.076,47
	azzurro	224S001 30	

Accessories:

<i>Decentralization kit</i> for steel cables	KIT DEC B	27,73
for steel cables + canopy	KIT DEC F	48,74
canopy for electrical dec.	KIT DEC M	85,71

Colours: grigio, azzurro

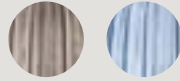

Special colours on request

Weight:
net kg 23,00

• **H. 10 m on demand:**
lead times to be checked with the sales department

Halo, LED retrofit light bulbs not included
→ specifications p. 190

Decentralization
→ specifications p. 124

LED and dimming
→ specifications p. 189

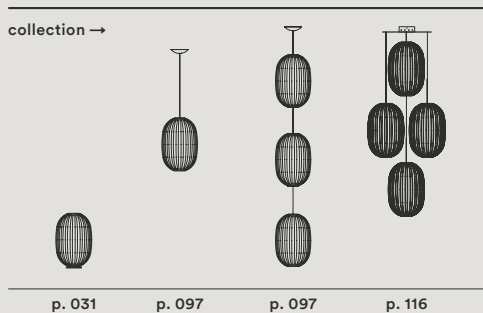
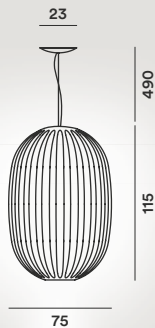

Plass media

Luca Nichetto, 2015



Rotational moulded
polycarbonate and steel

LED retrofit or Fluo
1x20W E27+1x8W GU10
Halo 1x116W E27
+ 1x75W GU10

⊕ CE IP 20

doppia tripla quadrupla

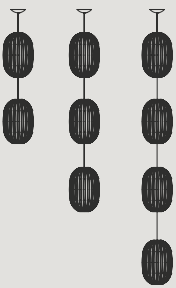

34

	energy cl.	colours	code	vat excluded
<i>Plass media E27+GU10</i>	A ⁺ , A	grigio	2240072 25	493,70
		azzurro	2240072 30	
<i>Plass media 1 x E27</i>	A ⁺ , A	grigio	2240172 25	409,67
		azzurro	2240172 30	
<i>Plass media E27+GU10 h. 10 m •</i>	A ⁺ , A	grigio	2240072/10-25	575,64
		azzurro	2240072/10-30	
<i>Plass media 1 x E27 h. 10 m •</i>	A ⁺ , A	grigio	2240172/10-25	491,59
		azzurro	2240172/10-30	
<i>Plass media doppia</i>	A ⁺ , A	grigio	2240072/2 25	1.026,06
		azzurro	2240072/2 30	
<i>Plass media tripla</i>	A ⁺ , A	grigio	2240072/3 25	1.470,60
		azzurro	2240072/3 30	
<i>Plass media quadrupla</i>	A ⁺ , A	grigio	2240072/4 25	1.915,14
		azzurro	2240072/4 30	
Spare parts:				
<i>Lampshade Plass media</i>		grigio	224S002R1 25	241,18
		azzurro	224S002R1 30	

Colours: grigio, azzurro

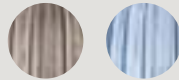

Special colours
on request

Weight:
net kg 3,50

• **H. 10 m on demand:**
lead times to be
checked with the
sales department

Halo, Fluo LED retrofit
light bulbs not included
→ specifications p. 190

Multiple canopy
→ specifications p. 116

Decentralization
→ specifications p. 124

collection →

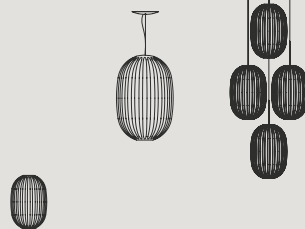

p. 031

p. 096

p. 116



Rituals + Rituals XL

Ludovica + Roberto
Palomba, 2013-2015



	energy cl.	colours	code	vat excluded
<i>Rituals 1</i>	A ⁺ , A	bianco	2440071E 10	371,01
<i>Rituals 2</i>	A ⁺ , A	bianco	2440072E 10	371,01
<i>Rituals 3</i>	A ⁺ , A	bianco	2440073E 10	315,55
<i>Rituals XL</i>	A ⁺ , A	bianco	2440074 10	510,51
<i>Rituals XL LED</i>	A ⁺	bianco	2440074L 10	559,67
<i>Rituals XL LED dimmable</i>	A ⁺	bianco	2440074LD 10	613,45
<i>Rituals 1 h. 10 m •</i>	A ⁺ , A	bianco	2440071E/1010	434,75
<i>Rituals 2 h. 10 m •</i>	A ⁺ , A	bianco	2440072E/1010	434,75
<i>Rituals 3 h. 10 m •</i>	A ⁺ , A	bianco	2440073E/1010	379,29
<i>Rituals XL h. 10 m •</i>	A ⁺ , A	bianco	2440074/10-10	574,23
<i>Rituals XL LED h. 10 m •</i>	A ⁺	bianco	2440074L/1010	599,73
<i>Rituals XL LED dimm. h. 10 m •</i>	A ⁺	bianco	2440074LD1010	653,49

Blown engraved satin glass and lacquered metal

Colours: bianco



Weight:
Rituals 1
net kg 3,80

Halo, Fluo, LED retrofit light bulbs not included
→ specifications p. 190

Rituals 1-2-3 E27
LED retrofit or Fluo 1x15W
Halo 1x70W

Rituals 2
net kg 4,00

Multiple canopy
→ specifications p. 116

Rituals XL
LED retrofit or Fluo
1x25W E27
Halo 1x150W E27

Rituals 3
net kg 1,50

Decentralization
→ specifications p. 124

Rituals XL LED included
24W COB 2700° K
2676 lm CRI>90 111 lm/W
Dimmable version
Possible configurations:
On-Off/Push/DALI

Rituals XL
net kg 5,90

LED and dimming,
Rituals XL LED
→ specifications p. 189

•
H. 10 m on demand:
lead times to be checked with the sales department

On request on/off or dimmable
24W COB 3000° K
3385 lm CRI>80 141 lm/W



Tecnico — 2018

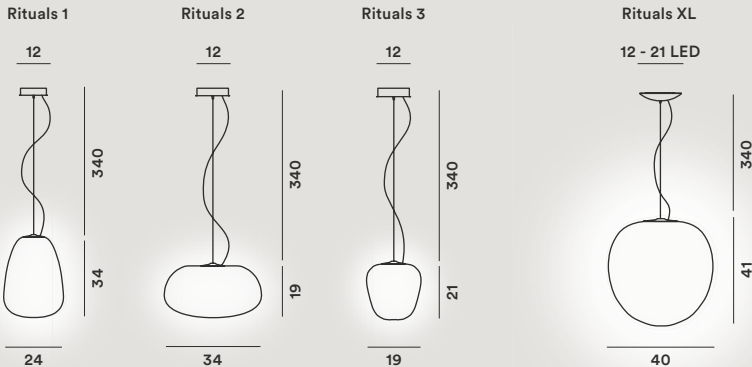

Spare parts:

	energy cl.	colours	code	vat excluded
<i>Glass Rituals 1</i>		bianco	244S001 10	221,85
<i>Glass Rituals 2</i>		bianco	244S002 10	221,85
<i>Glass Rituals 3</i>		bianco	244S003 10	166,39
<i>Glass Rituals XL</i>		bianco	244S004 10	315,13

Accessories:

<i>Decentralization kit</i> for steel cables			KIT DEC B	27,73
			for steel cables + canopy	48,74
			canopy for electrical dec.	85,71

collection →

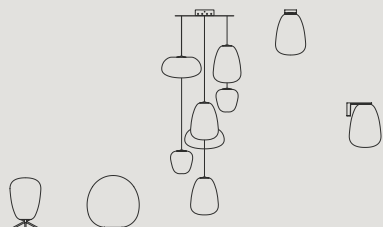

p. 034

p. 035

p. 116

p. 140

p. 167

Rituals XL LED

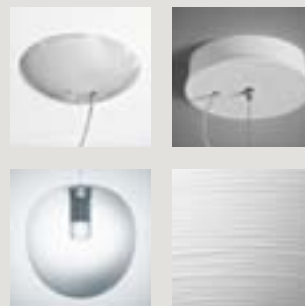

Satellite

Eugeni Quitllet, 2017



	energy cl.	colours	code	vat excluded
<i>Satellite</i>	A ⁺	bianco/trasp.	285007/3-15	593,27
<i>Satellite h. 10 m</i> •	A ⁺	bianco/trasp.	285007/10-15	633,31

Spare parts:

<i>External glass</i>	trasparente	285RV071-15	447,53
<i>Inner glass</i>	bianco	285RV072-10	92,02

Accessories:

<i>Decentralization kit</i> for steel cables		KIT DEC B	27,73
	for steel cables + canopy	KIT DEC F	48,74
	canopy for electrical dec.	KIT DEC M	85,71

Blown glass

LED retrofit included
21W E27 2700°K
2500 lm CRI>80
Dimmable with
TRIAC technology



Colours:
bianco/trasparente



Weight:
net kg 4,50

LED and dimming,
→ specifications p. 189

•
H. 10 m on demand:
lead times to be
checked with the
sales department

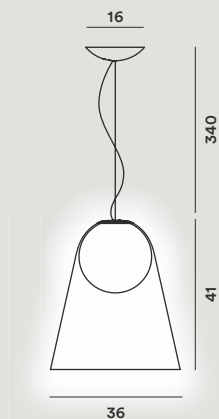

collection →

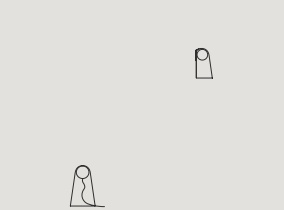

Supernova

Ferruccio Laviani, 2000



Lacquered or natural aluminium

LED retrofit or Fluo 1x23W E27

White globe bulb recommended
Ø 12 cm

⊕ Ⓢ IP 20

	energy cl.	colours	code	vat excluded
<i>Supernova</i>	A ⁺ , A	alluminio	102007/3-20	1.145,38
		fucsia	102007/3-66	
<i>Supernova XL</i> on request		alluminio	102007SP7 20	5.377,31
		fucsia	102007SP7 66	

Accessories:

<i>Decentralization kit</i> for steel cables	KIT DEC B	27,73
for steel cables + canopy	KIT DEC F	48,74
canopy for electrical dec.	KIT DEC M	85,71

Colours: alluminio, fucsia



Weight:
Supernova
net kg 8,00

Supernova XL
net kg 19,50

Fluo, LED retrofit light bulbs not included
→ specifications p. 190

Decentralization
→ specifications p. 124

Supernova

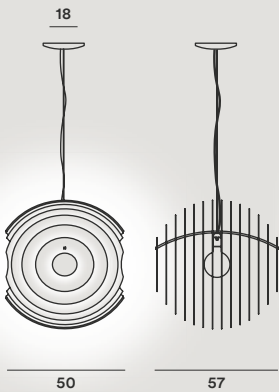

Supernova XL

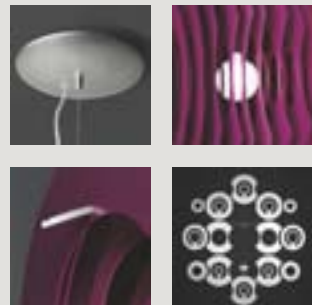
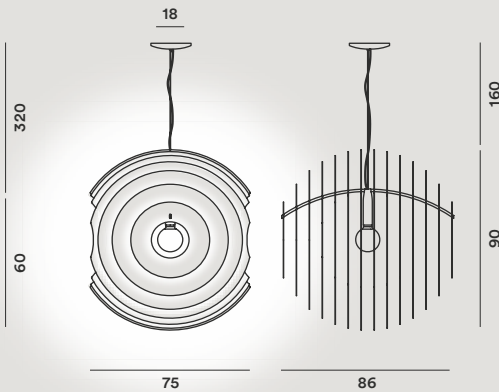

**Spokes +
Spokes 2 large**

Garcia Cumini, 2015 - 2016



Varnished steel and aluminium

LED included
38,2W (32,7 Cob + 5,5 High power) 2700° K 3264 lm
CRI>90 83 lm/W

Dimmable version
Possible configurations:
On-Off/Push/DALI



	energy cl.	colours	code	vat excluded
Spokes 1	A	bianco	2640071 10	870,17
		giallo	2640071 55	
		grafite	2640071-22	937,40
		rame	2640071-80	
Spokes 1 dimmable	A	bianco	2640071D 10	928,99
		giallo	2640071D 55	
		grafite	2640071D-22	996,22
		rame	2640071D-80	
Spokes 2	A	bianco	2640072 10	855,04
		giallo	2640072 55	
		grafite	2640072-22	922,27
		rame	2640072-80	
Spokes 2 dimmable	A	bianco	2640072D 10	913,86
		giallo	2640072D 55	
		grafite	2640072D-22	981,09
		rame	2640072D-80	
Spokes 2 large	A	bianco	2640172 10	1.344,53
		giallo	2640172 55	
		grafite	2640172-22	1.435,03
		rame	2640172-80	

Colours: bianco, giallo, grafite, rame

Weight:
Spokes 1
net kg 4,40

Decentralization
→ specifications p. 124



Spokes 2
net kg 4,40

LED and dimming,
→ specifications p. 189



Spokes 2 Large
net kg 6,00

Special colours
on request

Tecnico — 2018

Spokes 1



Spokes 2

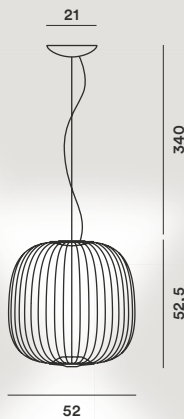

Spokes 2 large

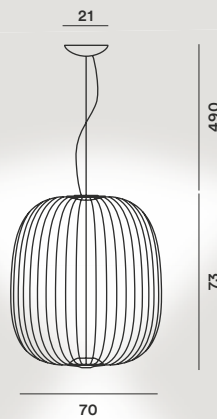

	energy cl.	colours	code	vat excluded
Spokes 1 h. 10 m •	A	bianco	2640071/10-10	933,89
		giallo	2640071/10-55	
		grafite	2640071/10-22	1.001,12
		rame	2640071/10-80	
Spokes 1 dimmerabile h. 10 m •	A	bianco	2640071D/1010	992,71
		giallo	2640071D/1055	1.059,94
		grafite	2640071D/1022	
		rame	2640071D/1080	
Spokes 2 h. 10 m •	A	bianco	2640072/10-10	918,76
		giallo	2640072/10-55	986,01
		grafite	2640072/10-22	
		rame	2640072/10-80	
Spokes 2 dimmerabile h. 10 m •	A	bianco	2640072D/1010	977,58
		giallo	2640072D/1055	1.044,83
		grafite	2640072D/1022	
		rame	2640072D/1080	
Spokes 2 large dimmerabile h. 10 m •	A	bianco	2640172/10-10	1.393,56
		giallo	2640172/10-55	1.484,07
		grafite	2640172/10-22	
		rame	2640172/10-80	
Accessories:		Decentralization kit for steel cables	KIT DEC B	27,73

•
H. 10 m on demand:
lead times to be checked
with the sales department



TartanLudovica + Roberto
Palomba, 2015

LED

Blown acid-etched glass
with reliefs**Tartan E27**
LED retrofit or Fluo
1x25W E27
Halo 1x150W E27**Tartan LED** included
24W COB 2700° K
2676 lm CRI>90 111 lm/W
Dimmable version
Possible configurations:
On-Off/Push/DALIOn request on/off or
dimmable
24W COB 3000° K
3385 lm CRI>80 141 lm/W

	energy cl.	colours	code	vat excluded
Tartan E27	A ⁺ , A	bianco	273007 10	422,27
		grigio	273007 24	
Tartan LED	A ⁺	bianco	273007L 10	471,43
		grigio	273007L 24	
Tartan LED dimmable	A ⁺	bianco	273007LD 10	525,21
		grigio	273007LD 24	
Tartan E27 h. 10 m •	A ⁺ , A	bianco	273007/10-10	485,99
		grigio	273007/10-24	
Tartan LED h. 10 m •	A ⁺	bianco	273007L/10-10	511,49
		grigio	273007L/10-24	
Tartan LED dimmable	A ⁺	bianco	273007LD/1010	565,25
10 m •		grigio	273007LD/1024	

Spare parts:

lampshade Tartan	bianco	273S00 10	226,89
	grigio	273S00 24	

Accessories:

Decentralization kit for steel cables		KIT DEC B	27,73
	for steel cables + canopy	KIT DEC F	48,74
	canopy for electrical dec.	KIT DEC M	85,71

Colours: bianco, grigio

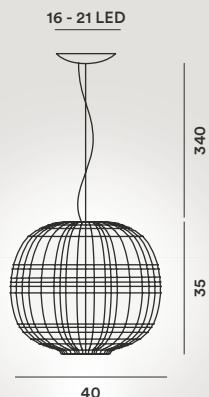
**Weight**
Tartan
net kg 4,60**Tartan LED**
net kg 5,20•
H. 10 m on demand:
lead times to be
checked with the
sales department**Halo, Fluo, LED retrofit**
light bulbs not included
→ specifications p. 190**Multiple canopy**
→ specifications p. 116**Decentralization**
→ specifications p. 124**LED and dimming,**
→ specifications p. 189

Tite

Marc Sadler, 2000



Fiberglass fabric with carbonium thread and nickel-plated steel

LED retrofit or Fluo
1x25W E27
Halo 1x116W E27

⊕ CE IP 20

	energy cl.	colours	code	vat excluded
<i>Tite 1</i>	A ⁺ , A	nero	111017 20	489,92
<i>Tite 2</i>	A ⁺ , A	nero	111027 20	382,36
<i>Tite 1 h. 10 m •</i>	A ⁺ , A	nero	111017/10-20	544,54
<i>Tite 2 h. 10 m •</i>	A ⁺ , A	nero	111027/10-20	436,98

Spare parts:

<i>Lampshade Tite 1</i>	nero	111S001 20	342,86
<i>Lampshade Tite 2</i>	nero	111S002 20	245,38

Accessories:

<i>Decentralization kit</i> for power cable		KIT DEC C	32,77
	canopy for electrical dec.	KIT DEC M	85,71

Colours: nero



Weight:

Tite 1
net kg 1,40

Tite 2
net kg 1,00

•
H. 10 m on demand:
lead times to be
checked with the
sales department

Halo, Fluo, LED retrofit
light bulbs not included
→ specifications p. 190

Multiple canopy
→ specifications p. 116

Decentralization
→ specifications p. 124

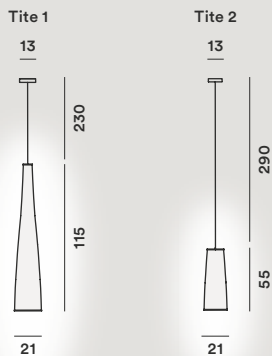

collection →

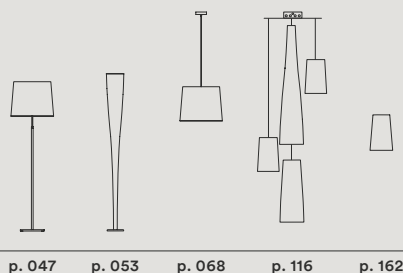

p. 047 p. 053 p. 068 p. 116 p. 162



Tress

Marc Sadler, 2009



Coated fibreglass-based composite material and chromed metal

Tress media or *Tress piccola*
LED retrofit
1x9,5W E27 PAR 30

Tress mini
LED retrofit
1x8W GU10 PAR 16



	energy cl.	colours	code	vat excluded
<i>Tress media</i>	A ⁺ , A	bianco	182017 10	671,86
		nero	182017 20	
		cremisi	182017 67	
		greige	182017 25	
		indaco	182017 87	
<i>Tress piccola</i>	A ⁺ , A	bianco	182027 10	486,98
		nero	182027 20	
		cremisi	182027 67	
		greige	182027 25	
		indaco	182027 87	
<i>Tress mini</i>	A ⁺ , A, C	bianco	182037 10	415,55
		nero	182037 20	
		cremisi	182037 67	
		greige	182037 25	
		indaco	182037 87	

Colours: bianco, nero, cremisi, greige, indaco

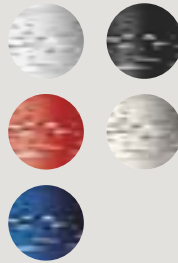

Special colours on request

Weight:

Tress media
net kg 2,40

Tress piccola
net kg 1,60

Tress mini
net kg 1,10

LED retrofit light bulbs not included
→ specifications p. 190

Multiple canopy
→ specifications p. 116

Decentralization
→ specifications p. 124

media



piccola



mini



collection →

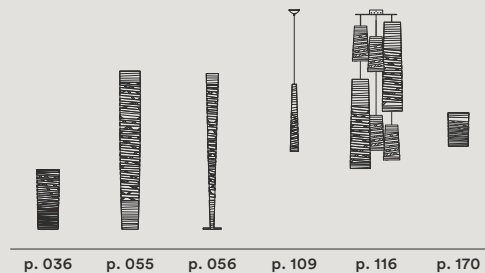

media/piccola



mini



	energy cl.	colours	code	vat excluded
Tress media h. 10 m •	A ⁺ , A	bianco	182017/10-10	724,66
		nero	182017/10-20	
		cremisi	182017/10-67	
		greige	182017/10-25	
		indaco	182017/10-87	
Tress piccola h. 10 m •	A ⁺ , A	bianco	182027/10-10	539,78
		nero	182027/10-20	
		cremisi	182027/10-67	
		greige	182027/10-25	
		indaco	182027/10-87	
Tress mini h. 10 m •	A ⁺ , A, C	bianco	182037/10-10	468,35
		nero	182037/10-20	
		cremisi	182037/10-67	
		greige	182037/10-25	
		indaco	182037/10-87	
Spare parts:	Lampshade Tress media	bianco	182S02 10	490,76
		nero	182S02 20	
		cremisi	182S02 67	
		greige	182S02 25	
		indaco	182S02 87	
	Lampshade Tress piccola	bianco	182S01 10	305,88
		nero	182S01 20	
		cremisi	182S01 67	
		greige	182S01 25	
		indaco	182S01 87	
	Lampshade Tress mini	bianco	182S0012 10	282,35
		nero	182S0012 20	
		cremisi	182S0012 67	
		greige	182S0012 25	
		indaco	182S0012 87	
Accessories:	Decentralization kit for steel cables		KIT DEC B	27,73
	for steel cables + canopy		KIT DEC F	48,74
	for power cable		KIT DEC C	32,77
	canopy for electrical dec.		KIT DEC M	85,71

•
H. 10 m on demand:
lead times to be checked
with the sales department

Tress grande

Marc Sadler, 2009



Coated fibreglass-based composite material, chromed metal and aluminium

Tress grande LED included
35W Mid power 3000°K
3665 lm CRI > 90 104,4 lm/W
Dimmable version
Possible configurations:
On-Off/Push/DALI

Tress grande
LED retrofit or Halo
1x160W R7s



• **H. 10 m on demand:**
lead times to be checked
with the sales department

	energy cl.	colours	code	vat excluded
Tress grande LED	A ⁺	bianco	182007L 10	1.205,88
		nero	182007L 20	
		cremisi	182007L 67	
		greige	182007L 25	
		indaco	182007L 87	
Tress grande LED dimmable	A ⁺	bianco	182007LD 10	1.273,10
		nero	182007LD 20	
		cremisi	182007LD 67	
		greige	182007LD 25	
		indaco	182007LD 87	
Tress grande	A ⁺	bianco	182007 10	792,43
		nero	182007 20	
		cremisi	182007 67	
		greige	182007 25	
		indaco	182007 87	
Tress grande LED h. 10 m •	A ⁺	bianco	182007L/10-10	1.318,76
		nero	182007L/10-20	
		cremisi	182007L/10-67	
		greige	182007L/10-25	
		indaco	182007L/10-87	
Tress grande LED dimmable h. 10 m •	A ⁺	bianco	182007LD/1010	1.385,98
		nero	182007LD/1020	
		cremisi	182007LD/1067	
		greige	182007LD/1025	
		indaco	182007LD/1087	
Tress grande h. 10 m •	A ⁺	bianco	182007/10-10	905,31
		nero	182007/10-20	
		cremisi	182007/10-67	
		greige	182007/10-25	
		indaco	182007/10-87	
Spare parts:				
Lampshade Tress grande		bianco	182S04 10	462,18
		nero	182S04 20	
		cremisi	182S04 67	
		greige	182S04 25	
		indaco	182S04 87	
Accessories:				
Decentralization kit for steel cables			KIT DEC B	27,73

Colours: bianco, nero, cremisi, greige, indaco

Weight:
LED net kg 5,80

Halo, LED retrofit light bulbs not included
→ specifications p. 190

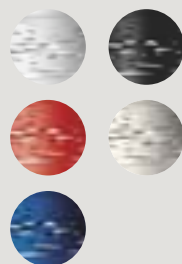

Halogen net kg 4,90

Decentralization → specifications p. 124

LED and dimming → specifications p. 189

collection →

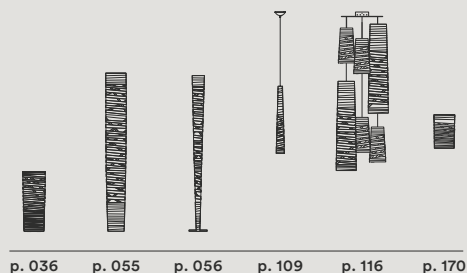

48

Tress Stilo

Marc Sadler, 2011



Coated fibreglass-based composite material, stainless steel and polycarbonate

LED retrofit
1x8W GU10 PAR 16



	energy cl.	colours	code	vat excluded
<i>Tress Stilo</i>	A+, A, C	bianco	182047R1-10	327,74
		nero	182047R1-20	
<i>Tress Stilo h. 10 m •</i>	A+, A, C	bianco	182047R1/1010	382,36
		nero	182047R1/1020	

Accessories:

<i>Decentralization kit</i> for power cable	KIT DEC C	32,77
canopy for electrical dec.	KIT DEC M	85,71

Colours: bianco, nero



Special colours on request

Weight:
net kg 0,50

• **H. 10 m on demand:**
lead times to be checked with the sales department

LED retrofit light bulbs not included
→ specifications p. 190

Multiple canopy
→ specifications p. 116

Decentralization
→ specifications p. 124



7

collection →

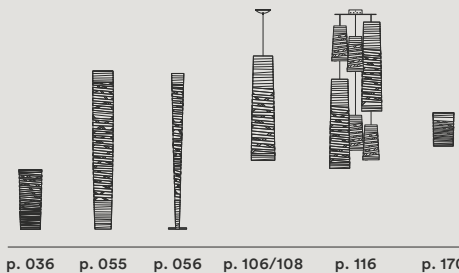

Troag

Luca Nichetto, 2010



Curved plywood and PMMA

Troag grande
Fluo 1x80W G5

Troag media
Fluo 1x54W G5

Troag piccola
Fluo 1x24W G5

On request dimmable version
Possible configurations:
On-Off/Push/DALI
Ⓢ CE IP 20

	energy cl.	colours	code	vat excluded
<i>Troag grande</i>	A ⁺ , A	bianco	2050071 10	899,16
		nero	2050071 20	
		naturale	2050071 50	
<i>Troag media</i>	A ⁺ , A	bianco	205007/3-10	739,50
		nero	205007/3-20	
		naturale	205007/3-50	
<i>Troag piccola</i>	A ⁺ , A	bianco	2050072/3-10	635,30
		nero	2050072/3-20	
		naturale	2050072/3-50	
<i>Troag grande h. 10 m</i> •	A ⁺ , A	bianco	2050071SP1010	949,58
		nero	2050071SP1020	
		naturale	2050071SP1050	
<i>Troag media h. 10 m</i> •	A ⁺ , A	bianco	205007SP10 10	805,04
		nero	205007SP10 20	
		naturale	205007SP10 50	
<i>Troag piccola h. 10 m</i> •	A ⁺ , A	bianco	2050072SP1010	700,84
		nero	2050072SP1020	
		naturale	2050072SP1050	

Accessories:

<i>Decentralization kit</i> canopy for electrical dec.	KIT DEC M	85,71
--	-----------	-------

Colours: bianco, nero, naturale



Weight:

Troag grande
net kg 3,50

Troag media
net kg 2,80

Troag piccola
net kg 1,80

Fluo light bulbs

not included
→ specifications p. 190

Decentralization
→ specifications p. 124

LED and dimming,
→ specifications p. 189

•
H. 10 m on demand:
lead times to be checked with the sales department

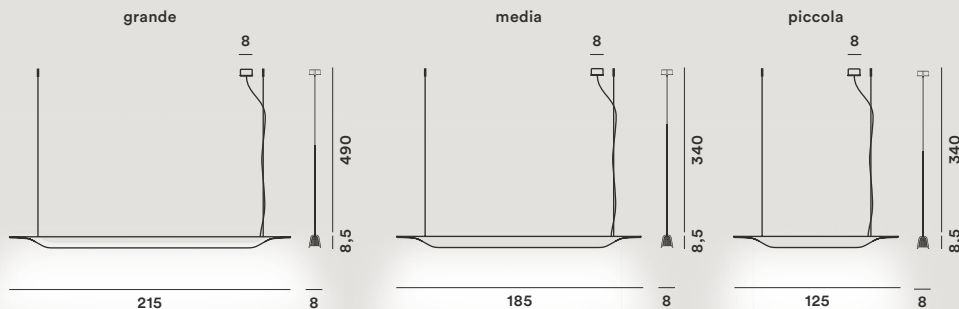

Tropico

Giulio Iacchetti, 2008

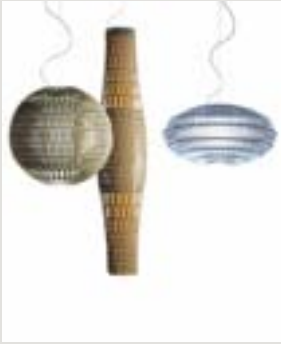

Injection moulded polycarbonate and chromed metal

Tropico Vertical

Fluo 1x40W max 2G11
Multiwatt electronic ballast
24/36/40

Tropico Sphera

Fluo 1x42W max GX24q-4
Multiwatt electronic ballast
26/32/42

Tropico Ellipse

Fluo 1x42W max GX24q-4
Multiwatt electronic ballast
26/32/42

Ⓢ CE IP 20

	energy cl.	colours	code	vat excluded
<i>Tropico Vertical</i>	A ⁺ , A	ghiaccio*	179072 16	1.172,28
		avorio*	179072 50	
<i>Tropico Sphera</i>	A ⁺ , A	ghiaccio*	179073 16	1.063,03
		avorio*	179073 50	
<i>Tropico Ellipse</i>	A ⁺ , A	ghiaccio*	179074 16	953,78
<i>Tropico Vertical h. 5 m</i> •	A ⁺ , A	ghiaccio*	179072 16 SP5	1.203,37
		avorio*	179072 50 SP5	
<i>Tropico Sphera h. 5 m</i> •	A ⁺ , A	ghiaccio*	179073 16 SP5	1.094,12
		avorio*	179073 50 SP5	
<i>Tropico Ellipse h. 5 m</i> •	A ⁺ , A	ghiaccio*	179074 16 SP5	984,87

Spare parts:

<i>Set Tropico Vertical</i>	ghiaccio	179S002 16	365,55
	avorio	179S002 50	
<i>Set Tropico Sphera</i>	ghiaccio	179S003 16	372,27
	avorio	179S003 50	
<i>Set Tropico Ellipse</i>	ghiaccio	179S004 16	335,29

Accessories:

<i>Set colour filters Tropico Vertical</i>	blu/arancio	179S172-R1	159,66
<i>Set colour filters Tropico Sphera</i>	blu/arancio	179S173-R1	76,47
<i>Set colour filters Tropico Ellipse</i>	blu/arancio	179S174-R1	68,07
<i>Decentralization kit</i> for steel cables		KIT DEC B	27,73
	for steel cables + canopy	KIT DEC F	48,74
	canopy for electrical dec.	KIT DEC M	85,71

* limited stock available

Colours: ghiaccio*, avorio* Weight:

*limited stock available

Tropico Vertical
net kg 7,70

Tropico Sphera
net kg 6,50

Tropico Ellipse
net kg 6,50

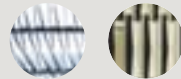

Fluo light bulbs
not included
→ specifications p. 190

Decentralization
→ specifications p. 124

•
H. 5 m on demand:
lead times to be
checked with the sales
department

Vertical

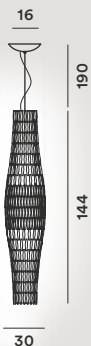

Sphera

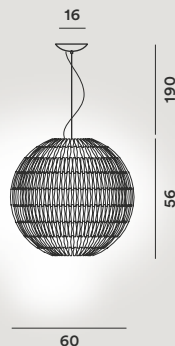

Ellipse

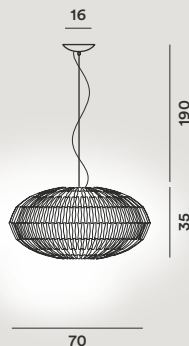

Twice as Twiggy

Marc Sadler, 2016



Coated fibreglass-based composite material, PMMA and aluminium

LED included
 81W (54 + 27 Mid-power)
 3000° K 8517 lm
 CRI>90 106 lm/W
 Dimmable
 Possible configurations:
 On-Off/Push/DALI



	energy cl.	colours	code	vat excluded
<i>Twice as Twiggy</i>	A ⁺	bianco	275017 10	2.394,96
		nero	275017 20	
		greige	275017 25	
		cremisi	275017 67	
		indaco	275017 87	
<i>Twice as Twiggy h. 10 m •</i>	A ⁺	bianco	275017/10-10	2.408,96
		nero	275017/10-20	
		greige	275017/10-25	
		cremisi	275017/10-67	
		indaco	275017/10-87	

Spare parts:

<i>Lampshade Twice as Twiggy</i>	bianco	275S001 10	1.917,65
	nero	275S001 20	
	greige	275S001 25	
	cremisi	275S001 67	
	indaco	275S001 87	

Colours: bianco, nero, cremisi, greige, indaco

Weight: net kg 8,40

LED and dimming, → specifications p. 189

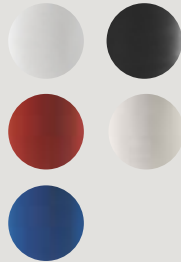

• **H. 10 m on demand:**
 lead times to be checked with the sales department

Special colours on request

Tecnico — 2018

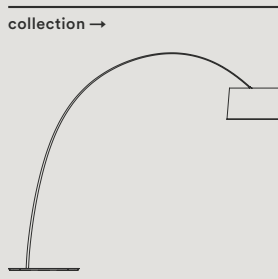
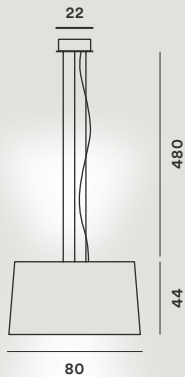

p. 058



Twiggy

Marc Sadler, 2007



Coated fibreglass-based composite material, PMMA, and polycarbonate

LED retrofit or Fluo
3x20W E27
Halo 3x77W E27

⊕ CE IP 20

	energy cl.	colours	code	vat excluded
<i>Twiggy grande</i>	A ⁺ , A	bianco	159007 10	693,28
		nero	159007 20	
<i>Twiggy grande h. 10 m</i> •	A ⁺ , A	bianco	275017/10-10	711,48
		nero	159017/10-20	

Spare parts:

<i>Lampshade Twiggy grande</i>	bianco	159S10 10	463,87
	nero	159S10 20	
<i>Lower diffusor disk</i>		159R05	32,77

Accessories:

<i>Decentralization kit</i> for power cable		KIT DEC C	32,77
	canopy for electrical dec.	KIT DEC M	

Colours: bianco, nero



Special colours
on request

Weight:
net kg 1,80

•
H. 10 m on demand:
lead times to be
checked with the
sales department

Halo, Fluo, LED retrofit
light bulbs not included
→ specifications p. 190

Decentralization
→ specifications p. 124

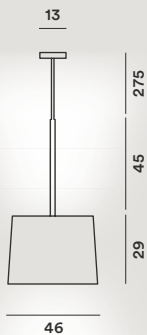

collection →

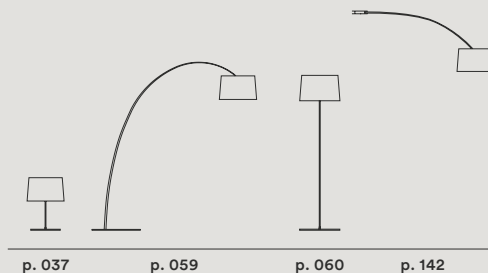

Uto

Lagranja Design, 2005



	energy cl.	colours	code	vat excluded
Uto	A ⁺ , A	bianco	142000 10	348,74
		giallo	142000 50	
		arancio	142000 53	

Thermoplastic elastomer and polycarbonate

LED retrofit or Fluo
1x15W E27
Switch inside the flexible tube

CE IP 20

Colours: bianco, giallo, arancio



Weight:
net kg 2,00

Fluo, LED retrofit light bulbs not included
→ specifications p. 190

Tecnico — 2018

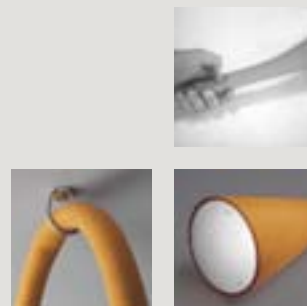
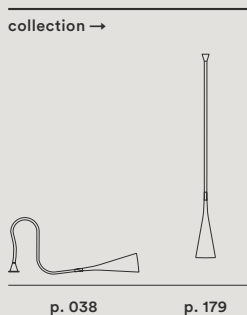
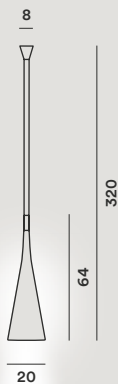

Accessori, Accessories

116 **Rosone multiplo tondo**

116 **Rosone multiplo lineare**

124 **Kit decentramento**

Multiple canopies



Round multiple canopy

Colour: white
Laquered metal

Weight: net kg 9,00

⊕ CE  IP 20

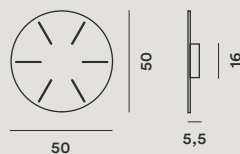

code: ROSONE01 10

vat excluded

415,13



Linear multiple canopy 90 cm

Colour: white
Laquered metal

Weight: net kg 7,00

⊕ CE  IP 20

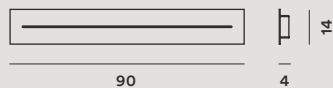

code: ROSONE02 10

vat excluded

348,74



Linear multiple canopy 135 cm

Colour: white
Laquered metal

Weight: net kg 10,00

⊕ CE  IP 20

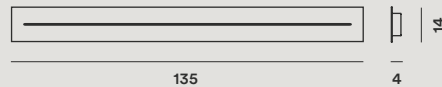

code: ROSONE03 10

vat excluded
463,87

Max refers
to installation
in staggered
composition

Model	round	linear 90	linear 135
<i>Aplomb - Aplomb mini</i>	max 9	max 6	max 9
<i>Arumi</i>	max 9	max 6	max 9
<i>Birdie grande</i>	max 6	max 6	max 9
<i>Birdie piccola</i>	max 9	max 6	max 9
<i>Buds ▲</i>	max 6	max 6	max 9
<i>Buds ▲</i>	max 6	max 4	max 6
<i>Buds ▲</i>	max 6	max 5	max 8
<i>Caboche piccola</i>	max 6	max 5	max 8
<i>Caiigo</i>	max 6	max 6	max 9
<i>Chouchin / reverse 1 ▲</i>	max 6	max 4	max 6
<i>Chouchin / reverse 2 ▲</i>	max 6	max 6	max 9
<i>Chouchin / reverse 3 ▲</i>	max 6	max 5	max 8
<i>Chouchin mini 1 - 2</i>	max 9	max 6	max 9
<i>Gem ▲</i>	max 5	max 4	max 5
<i>Gregg media ▲</i>	max 6	max 5	max 5
<i>Gregg MIDI</i>	max 6	max 6	max 6
<i>Gregg piccola</i>	max 9	max 6	max 9
<i>Havana</i>	max 6	max 6	max 9
<i>Maki</i>	max 9	max 6	max 9
<i>Plass media</i>	max 6	max 5	max 8
<i>Rituals 1</i>	max 6	max 6	max 9
<i>Rituals 2</i>	max 6	max 5	max 7
<i>Rituals 3</i>	max 9	max 6	max 9
<i>Rituals XL ▲</i>	max 5	max 4	max 5
<i>Satellight</i>	max 6	max 5	max 6
<i>Tartan ▲</i>	max 5	max 4	max 5
<i>Tite 1 - Tite 2</i>	max 9	max 6	max 9
<i>Tress media - Tress piccola</i>	max 6	max 6	max 9
<i>Tress mini - Tress Stilo</i>	max 9	max 6	max 9

▲ excluded integrated LED version

Round multiple canopy

Aplomb + Aplomb mini



Arumi



Birdie



Buds



Caboche piccola



Chouchin + Chouchin mini



Round multiple canopy

Gem



Gregg grande + media + MIDI



Gregg MIDI



Havana



Maki



Plass media



Round multiple canopy

Rituals XL



Tartan



Tite 1



Tite 2



Tress



Tress stilo



Linear multiple canopy

Aplomb + Aplomb mini



Birdie



Caboche piccola



Couchin



Couchin reverse



Gem



Linear multiple canopy

Rituals XL



Plass media



Satellite



Tartan



Tite 2



Tress



Linear multiple canopy

Rituals



Gregg piccola



Gregg MIDI



Maki



Decentralization kit



Kit B — Code: KIT DEC B

Decentralization kit, includes 3 supports for steel cables.

For the models: Allegretto, Allegro, Behive, Big Bang, Buds, Caboche, Caiigo, Chouchin, Chouchin Reverse, Chouchin mini, Gem, Gregg grande / media, Lightweight, Le Soleil, New Buds, O-Space, Planet, Plass, Plass media, Rituals, Rituals XL, Satellight, Supernova, Tartan, Tropico, Twice as Twiggy, Tress grande / media / piccola.

Weight: net kg 0,01

	vat excluded
	27,73



Kit C — Code: KIT DEC C

Decentralization for power cable.

For the models: Aplomb, Aplomb large, Aplomb mini, Birdie, Giga-Lite, Gregg piccola, Havana, Maki, Tite, Tress mini, Tress stilo, Twiggy

Weight: net kg 0,01

	vat excluded
	32,77





Kit F — Code: KIT DEC F



Decentralization kit, includes 3 supports for steel cables + spare canopy.

For the models: Pour les modèles : Allegretto, Allegro, Behive, Big Bang ▲, Buds ▲, Caboche ▲, Chouchin / reverse ▲, Chouchin mini, Gem, Gregg grande /media ▲, Le Soleil, O-Space, Planet, Plass ▲, Plass media, Rituals, Rituals xl ▲, Satellight, Supernova, Tartan ▲, Tropico, Tress grande ▲ /media / piccola.

▲ LED version excluded

Weight: net kg 0,03

vat excluded

48,74

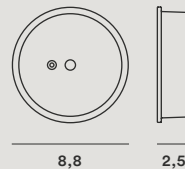

Kit M — Code: KIT DEC M



Canopy electrical decentralization up to 4 lamps.

The kit M contains only the canopy, to compositions as picture order the necessary quantity of Kit B or Kit C.

For the models: Aplomb, Aplomb mini, Arumi, Behive, Big Bang ▲, Birdie, Buds ▲, Caboche ▲, Chouchin / reverse ▲, Chouchin mini, Gem, Giga-Lite, Gregg ▲, Havana, Le Soleil, Maki, O-Space, Planet, Plass ▲, Plass media, Rituals, Rituals XL ▲, Satellight, Supernova, Tartan ▲, Tite, Tress ▲, Tress Stilo, Troag, Tropico, Twiggy.

▲ LED version excluded

Weight: net kg 0,01

vat excluded

85,71

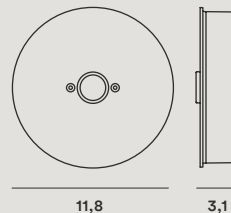



Soffitto, Ceiling

- | | | | |
|-----|-------------------------------|-----|------------------------------|
| 128 | Bahia +
Bahia mini | 136 | Folio |
| 129 | Big Bang | 137 | Gregg |
| 130 | Birdie | 138 | Lumiere
XXL + XXS |
| 132 | Blob S | 139 | Nuage |
| 133 | Caboche | 140 | Rituals |
| 134 | Circus | 141 | Tivu |
| 135 | Ellepi | 142 | Twiggy |

Bahia + Bahia mini

Lucidi e Pevere, 2010-2015

LED

	energy cl.	colours	code	vat excluded
<i>Bahia fluo</i>	A ⁺ , A	bianco	196005 10	445,38
<i>Bahia LED</i>	A ⁺	bianco	196005L 10	621,85
<i>Bahia LED dimmable</i>	A ⁺	bianco	196005LD 10	671,43
<i>Bahia mini fluo</i>	A ⁺ , A	bianco	1960052 10	247,90
<i>Bahia mini fluo dimmable</i>	A ⁺ , A	bianco	1960052D 10	310,92
<i>Bahia mini LED</i>	A ⁺	bianco	1960052L 10	399,16
<i>Bahia mini LED dimmable</i>	A ⁺	bianco	1960052LD 10	449,58

Injection moulded
polycarbonate

Bahia fluo
Fluo 1x40W + 1x22W 2GX13

Bahia LED included
43W Mid-power 2850° K
4210 lm CRI>90 97,9 lm/W
Dimmable version
Possible configurations:
On-Off/Push/DALI

Bahia mini fluo
Fluo 1x22W 2GX13
Dimmable version
Possible configurations:
On-Off/Push/DALI

Bahia mini LED included
21W Mid-power 2850° K
2425 lm CRI>90 115 lm/W
Dimmable version
Possible configurations:
On-Off/Push/DALI

⊕ CE IP 20

Colours: bianco



Weight:
Bahia
net kg 4,40

Bahia mini
net kg 2,70

Fluo light bulbs
not included
→ specifications p. 190

LED and dimming
→ specifications p. 189

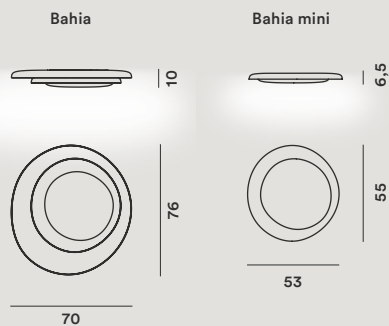

collection →



p. 147

p. 147



Big Bang

Enrico Franzolini con
Vicente Garcia Jimenez, 2005



Methacrylate and coated
metal

LED retrofit or Halo
1x120W R7s

⊕ CE IP 20

	energy cl.	colours	code	vat excluded
<i>Big Bang</i>	A ⁺ , A, C	bianco	151005 10	428,57
		rosso	151005 63	445,38
Spare parts:				
<i>Set lampshades Big Bang</i>		bianco	151S05 10	253,78
		rosso	151S05 63	270,59
<i>Halogen protection glass</i>			PIREX94/4/I	21,01

Colours: bianco, rosso

Weight:
net kg 3,00

Halo, LED retrofit
light bulbs not included
→ specifications p. 190

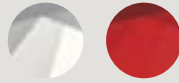

Special colours
on request

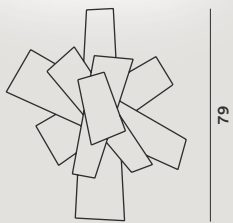

66

collection →

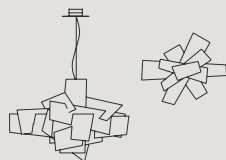

p. 072

p. 148

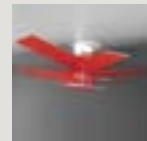

Birdie

Ludovica + Roberto
Palomba, 2012



Polycarbonate and coated aluminium

LED retrofit or Fluo
3-6-9x20W E27
Halo 1-3-6-9x70W E27

Different heights on request



	energy cl.	colours	code	vat excluded
Birdie 3	A+, A	bianco	2210083 10	718,49
		grigio	2210083 25	
		arancio	2210083 53	
		amaranto	2210083 65	
Birdie 6	A+, A	bianco	2210086 10	1.349,59
		grigio	2210086 25	
		arancio	2210086 53	
		amaranto	2210086 65	
Birdie 9	A+, A	bianco	2210089 10	1.997,49
		grigio	2210089 25	
		arancio	2210089 53	
		amaranto	2210089 65	

Spare parts:

Lampshade Birdie	bianco	221S002 10	46,22
	grigio	221S002 25	
	arancio	221S002 53	
	amaranto	221S002 65	

Colours: bianco, grigio, arancio, amaranto



Special colours on request

Weight:
Birdie 3
net kg 3,70

Birdie 6
net kg 6,60

Birdie 9
net kg 9,50

Halo, Fluo, LED retrofit light bulbs not included
→ specifications p. 190

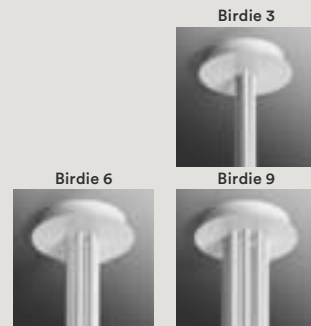
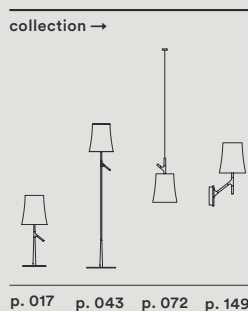
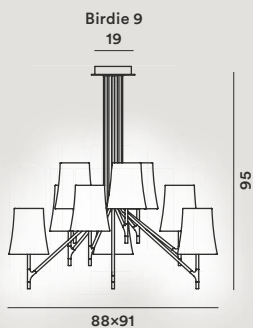
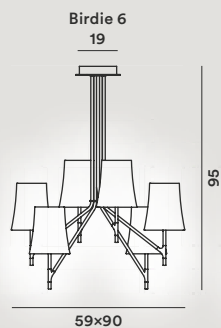
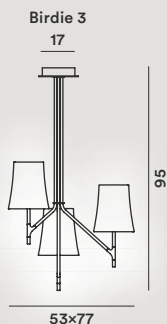

Birdie

Ludovica + Roberto
Palomba, 2013



Polycarbonate and coated aluminium

LED retrofit or Fluo
6-9x20W E27
Halo 6-9x60W E27



	energy cl.	colours	code	vat excluded
<i>Birdie 6 with cables</i>	A ⁺ , A	bianco	2210076 10	1.571,44
		grigio	2210076 25	
		arancio	2210076 53	
		amaranto	2210076 65	
<i>Birdie 9 with cables</i>	A ⁺ , A	bianco	2210079 10	2.219,34
		grigio	2210079 25	
		arancio	2210079 53	
		amaranto	2210079 65	
<i>Birdie 6 with cables</i> <i>h. 5 m •</i>	A ⁺ , A	bianco	2210076SP5 10	1.609,25
		grigio	2210076SP5 25	
		arancio	2210076SP5 53	
		amaranto	2210076SP5 65	
<i>Birdie 9 with cables</i> <i>h. 5 m •</i>	A ⁺ , A	bianco	2210079SP5 10	2.257,16
		grigio	2210079SP5 25	
		arancio	2210079SP5 53	
		amaranto	2210079SP5 65	
Spare parts:				
<i>Lampshade Birdie</i>		bianco	221S002 10	46,22
		grigio	221S002 25	
		arancio	221S002 53	
		amaranto	221S002 65	

Colours: bianco, grigio,
arancio, amaranto



Special colours
on request

Weight:
Birdie 6
net kg 6,60

Birdie 9
net kg 9,50

•
H. 5 m on demand:
lead times to be
checked with the
sales department

Halo, Fluo, LED retrofit
light bulbs not included
→ specifications p. 190

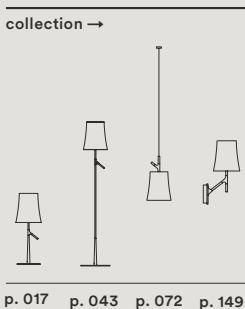
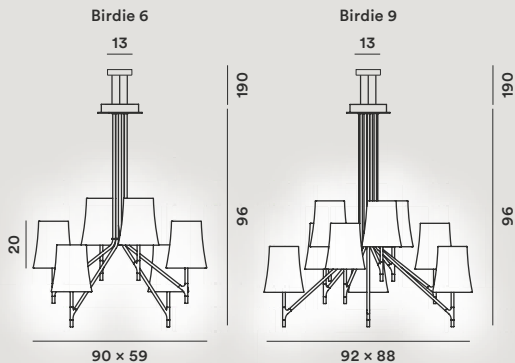

Blob S

Karim Rashid, 2002



	energy cl.	colours	code	vat excluded
<i>Blob S</i>	A ⁺ , A	bianco	124035 10	184,87
Spare parts:				
<i>Lampshade Blob S</i>		bianco	124S00 10	62,18

Rotational moulded polyethylene and coated metal

Fluo 1x24W 2G11

☐ CE IP 20

Colours: bianco



Weight:
net kg 1,10

Fluo light bulbs
not included
→ specifications p. 190

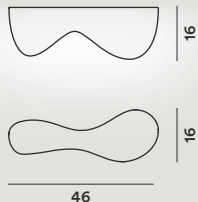

collection →



Caboche

Patricia Urquiola con
Eliana Gerotto, 2006



PMMA, blown glass and
chromed metal

LED retrofit or Halo
1x120W R7s

⊕ CE IP 20

	energy cl.	colours	code	vat excluded
<i>Caboche</i>	A ⁺ , A, C	trasparente	138008 16	773,11
		giallo oro	138008 52	
Spare parts:				
<i>Kit 10 spheres Caboche</i>		trasparente	138KIT 10SF16	39,50
		giallo oro	138KIT 10SF52	
<i>Kit 15 prongs 3 spheres Caboche</i>			138KIT 15M3	29,41
<i>Kit 15 prongs 4 spheres Caboche</i>			138KIT 15S4	29,41
<i>Kit 3+3 prongs 3-4 spheres Caboche</i>			138KIT3-R2	17,65
<i>Glass Caboche</i>			138V018/1	90,76
<i>Halogen protection glass</i>			PIREX138/2S4I	20,17

Colours: trasparente,
giallo oro

Weight:
net kg 9,10

Halo, LED retrofit
light bulbs not included
→ specifications p. 190



Special colours
on request

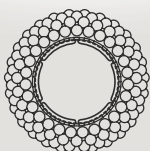
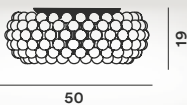

collection →

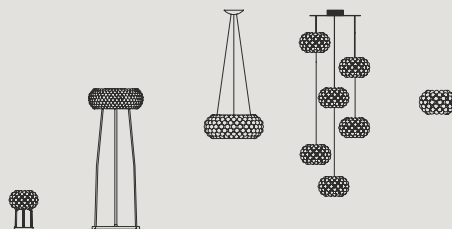

p. 020

p. 044

p. 076/078

p. 116

p. 152



Circus

Defne Koz, 1994



	energy cl.	colours	code	vat excluded
<i>Circus grande</i>	A ⁺ , A, B, C	bianco	0460081 11	420,17
<i>Circus piccola</i>	A ⁺ , A, B, C	bianco	046008 11	267,23

Spare parts:

<i>Glass Circus grande</i>	bianco	046S001 11	269,75
<i>Glass Circus piccola</i>	bianco	046S00 11	150,42

Blown glass, nickel-plated or coated metal

Circus grande
LED retrofit or Fluo
4x12W E27
Halo 4x46W E27

Circus piccola
LED retrofit or Fluo
4x8W E14
Halo 4x30W E14



Colours: bianco



Special colours
on request

Weight:
Circus grande
net kg 4,70

Circus piccola
net kg 2,10

Halo, Fluo, LED retrofit
light bulbs not included
→ specifications p. 190

grande



46

piccola



32

collection →



p. 153



Ellepi

Alessandra Matilde, 2003

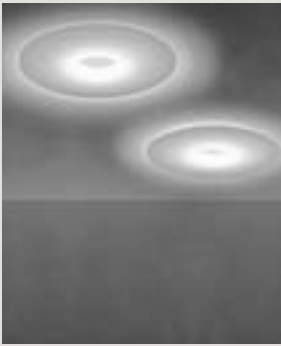

Methacrylate and coated
metal

Fluo 1x55W 2GX13

⊕ CE IP 20

	energy cl.	colours	code	vat excluded
<i>Ellepi</i>	A ⁺ , A	bianco	128005 10	399,16
Spare parts:				
<i>Lampshade Ellepi</i>		bianco	128S00 10	205,88

Colours: bianco



Special colours
on request

Weight:
net kg 4,30

Fluo light bulbs
not included
→ specifications p. 190



6,5

collection →

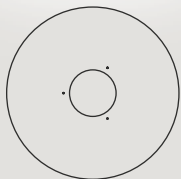

74



p. 155

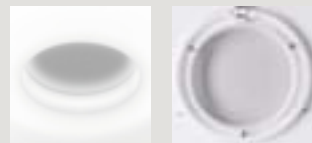

Folio

Carlo Urbinati e Alessandro Vecchiato, 1990

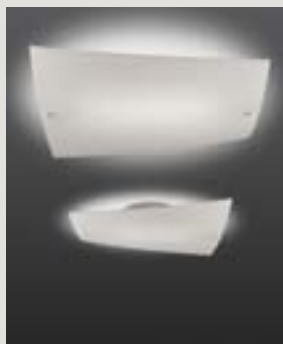

Blown acid-etched glass and coated metal

LED retrofit or Halo
1x120W R7s

⊕ CE IP 20

	energy cl.	colours	code	vat excluded
<i>Folio grande halogen</i>	A ⁺ , A, C	bianco	019008 10	358,82
Spare parts:				
<i>Glass Folio grande</i>		bianco	019S001 10	210,92
<i>Halogen protection glass</i>			PIREX94/4/I	21,01

Colours: bianco



Special colours
on request

Weight:
net kg 2,20

Halo, LED retrofit
light bulbs not included
→ specifications p. 190

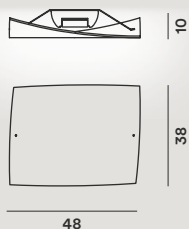

collection →



Gregg

Ludovica e Roberto
Palomba, 2007



Blown acid-etched and white lacquered metal

Gregg media
LED retrofit or Fluo
1x25W E27
Halo 1x150W E27



Gregg MIDI
LED included COB 8,5W
2700° K 700 lm CRI>90
Dimmable with
TRIAC technology



Gregg piccola
LED retrofit or Halo
1x20W G9



media

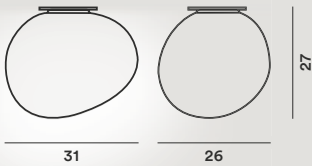

MIDI

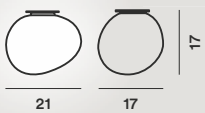

piccola



	energy cl.	colours	code	vat excluded
<i>Gregg media</i>	A ⁺ , A	bianco	168005 10	298,32
<i>Gregg MIDI</i>	A	bianco	1680053-10	234,45
<i>Gregg piccola</i>	A ⁺ , A, C	bianco	1680052 10	144,54
Spare parts:				
<i>Glass Gregg media</i>		bianco	168S00 10	171,43
<i>Glass Gregg MIDI</i>		bianco	168RV003-10	89,29
<i>Glass Gregg piccola</i>		bianco	168S00210	58,82

Colours: bianco



Special colours
on request

Weight:
Gregg media
net kg 2,90

Gregg MIDI
netto kg 1,60

Gregg piccola
net kg 0,60

Halo, Fluo, LED retrofit
light bulbs not included
→ specifications p. 190

collection →

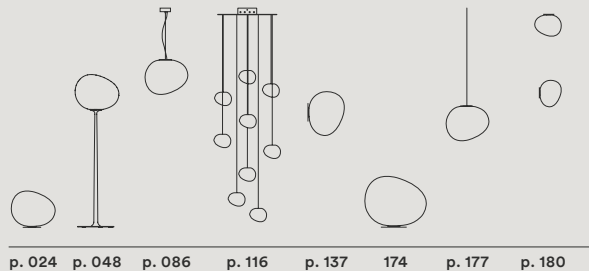

Lumiere XXL + XXS

Rodolfo Dordoni, 2010



Blown glass and lacquered metal

Lumiere XXL LED
LED included
55W 2700°K
4700 lm CRI>80
Dimmable with TRIAC technology

Lumiere XXL fluo
Fluo 1x40W + 1x22W 2GX13
dimmerabile 1x55W 2GX13
Dimmable version
Possible configurations:
On-Off/Push/DALI

Lumiere XXS LED
LED included
30W 2700°K
2200 lm CRI>80
Dimmable with TRIAC technology

Lumiere XXS fluo
Fluo 2x18W G24q-2



	energy cl.	colours	code	vat excluded
Lumiere XXL LED	A ⁺	bianco	191005L-11	369,75
		grigio	191005L-24	411,76
		marrone	191005L-55	
Lumiere XXL fluo	A ⁺ , A	bianco	191005 11	361,34
Lumiere XXL fluo dimm.	A ⁺ , A	bianco	191005DM 11	433,61
Lumiere XXS LED	A ⁺	bianco	1910052L-11	310,92
		grigio	1910052L-24	331,93
		marrone	1910052L-55	
Lumiere XXS fluo	A ⁺ , A	bianco	1910052 11	308,40
Spare parts:				
Glass Lumiere XXL		bianco	191S0051 11	202,52
		grigio	191S0051-24	244,53
		marrone	191S0051-55	
Glass Lumiere XXS		bianco	191S0052 11	146,22
		grigio	191S0052-24	167,23
		marrone	191S0052-55	

Colours: bianco, grigio
freddo, marrone freddo

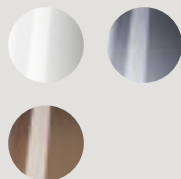

Special colours
on request

Weight:
Lumiere XXL
net kg 3,40

Lumiere XXS
net kg 1,80

Fluo light bulbs
not included
→ specifications p. 190

LED and dimming
→ specifications p. 189

Lumiere XXL

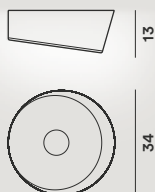

Lumiere XXS



collection →

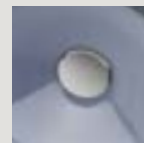
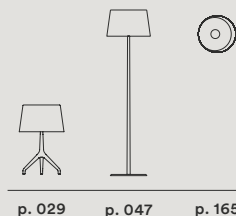

Nuage

Philippe Nigro, 2012



Injection-moulded polycarbonate and batch-dyed ABS

Fluo 1x40W + 1x22W 2GX13
dimnable 1x55W 2GX13
Dimmable version
Possible configurations:
On-Off/Push/DALI

Usable in composition

⊕ CE IP 20

	energy cl.	colours	code	vat excluded
Nuage	A ⁺ , A	bianco	243005 10	406,72
		rosso*	243005 63	
Nuage dimmable	A ⁺ , A	bianco	243005DM 10	459,66
		rosso*	243005DM 63	
Accessories				
Lamp connection kit	40+22W		243KIT	26,05
	dimmable		243KIT DM	40,34
Spare parts:				
Set lampshades Nuage		bianco	243S00 10	280,67
		rosso	243S00 63	

* Limited stock available

Colours: bianco,



rosso*

* Limited stock available



Weight:
net kg 3,20

Fluo light bulbs
not included
→ specifications p. 190

LED and dimming
→ specifications p. 189

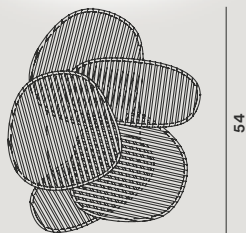
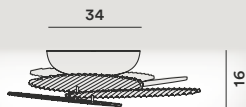

collection →

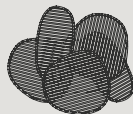

p. 166

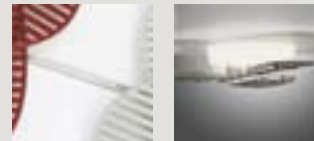

Rituals

Ludovica e Roberto
Palomba, 2015



Blown satin glass and
lacquered metal

LED retrofit or Fluo
1x20W E27
Halo 1x70W E27

⊕ CE IP 20

	energy cl.	colours	code	vat excluded
<i>Rituals 1</i>	A ⁺ , A	bianco	2440081 10	344,54
<i>Rituals 2</i>	A ⁺ , A	bianco	2440082 10	344,54
<i>Rituals 3</i>	A ⁺ , A	bianco	2440083 10	294,12
Spare parts:				
<i>Glass Rituals 1</i>		bianco	244S001 10	221,85
<i>Glass Rituals 2</i>		bianco	244S002 10	221,85
<i>Glass Rituals 3</i>		bianco	244S003 10	166,39

Colours: bianco



Weight:
Rituals 1
net kg 4,10

Rituals 2
net kg 4,20

Rituals 3
net kg 1,70

Halo, Fluo, LED retrofit
light bulbs not included
→ specifications p. 190

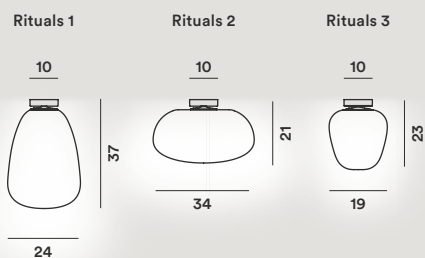

collection →

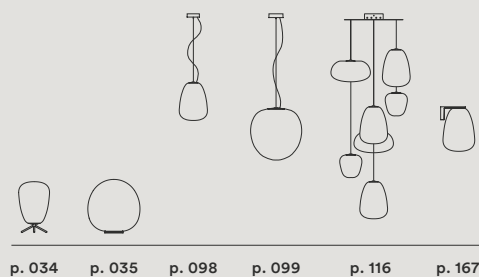

p. 034 p. 035 p. 098 p. 099 p. 116 p. 167



Tivu

Joseph Forakis, 2011



	energy cl.	colours	code	vat excluded
Tivu grande	A ⁺ , A	bianco*	207005 10	201,68
		nero*	207005 20	

* Limited stock available

Injection-moulded polycarbonate

Fluo 2x18W 2G11

⊕ CE IP 20

Colours: bianco*, nero*
* Limited stock available

Weight:
net kg 1,30

Fluo light bulbs
not included
→ specifications p. 190



collection →

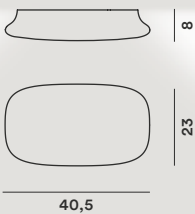

p. 169



Twiggy

Marc Sadler, 2007



	energy cl.	colours	code	vat excluded
<i>Twiggy</i>	A ⁺ , A	bianco	159008 10	949,58
		nero	159008 20	
Spare parts:				
<i>Lampshade Twiggy</i>		bianco	159S10 10	463,87
		nero	159S10 20	
<i>Lower diffusor disk</i>			159R05	32,77

Compound material on lacquered glass fibre base, PMMA and lacquered metal

LED retrofit or Fluo
3x20W E27
Halo 3x70W E27

Rotating 330°
Stem lenght cannot be changed

⚡ CE IP 20

Colours: bianco, nero



Special colours on request

Weight:
net kg 5,60

Halo, Fluo, LED retrofit light bulbs not included
→ specifications p. 190

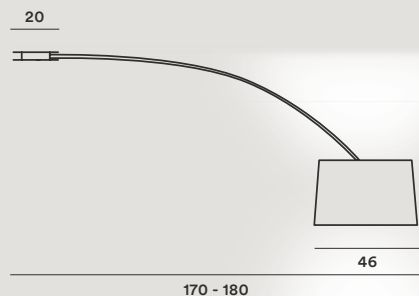

Tecnico — 2018

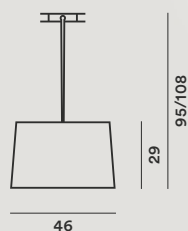

collection →

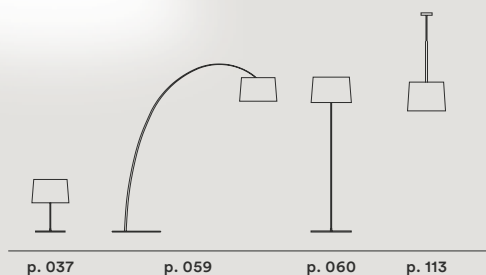



Parete, Wall

- | | | | |
|-----|-------------------------------|-----|------------------------------|
| 146 | Aplomb | 159 | Gregg |
| 147 | Bahia +
Bahia mini | 160 | Havana |
| 148 | Big Bang | 161 | Innerlight |
| 149 | Birdie | 162 | Kite |
| 150 | Bit | 163 | Lake |
| 151 | Blob S | 164 | Le Soleil |
| 152 | Caboche | 165 | Lumiere
XXL + XXS |
| 153 | Circus | 166 | Nuage |
| 154 | Double | 167 | Rituals |
| 155 | Ellepi | 168 | Satellight |
| 156 | Fields | 169 | Tivu |
| 157 | Filo | 170 | Tress |
| 158 | Folio | 171 | Tutù |

Aplomb

Lucidi e Pevere, 2014



	energy cl.	colours	code	vat excluded
<i>Aplomb</i>	A ⁺	bianco	195005L 10	415,97
		grigio	195005L 25	
		marrone	195005L 52	

Concrete, varnished metal and aluminium

LED included
13W Acrich 2700°K 1120 lm
CRI > 80 86 lm/W
Dimmable only with Seoul-Acrich LED compatible modules



Colours: bianco, grigio cemento, marrone

Weight: net kg 2,00



Tecnico — 2018



30



15

24

collection →

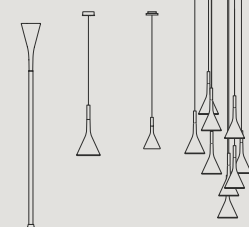

p. 042 p. 066 p. 067 p. 116



Bahia + Bahia mini

Lucidi e Pevere, 2010-2015

LED



Injection moulded
polycarbonate

Bahia fluo
Fluo 1x40W + 1x22W 2GX13

Bahia LED included
43W Mid-power 2850° K
4210 lm CRI>90 97,9 lm/W
Dimmable version
Possible configurations:
On-Off/Push/DALI"

Bahia mini fluo
Fluo 1x22W 2GX13
Dimmable version
Possible configurations:
On-Off/Push/DALI

Bahia mini LED included
21W Mid- power 2850° K
2425 lm CRI>90 115 lm/W
Dimmable version
Possible configurations
On-Off/Push/DALI

⊕ CE IP 20

Colours: bianco



Weight:
Bahia
net kg 4,40

Bahia mini
net kg 2,70

Fluo light bulbs
not included
→ specifications p. 190

LED and dimming
→ specifications p. 189

	energy cl.	colours	code	vat excluded
<i>Bahia fluo</i>	A ⁺ , A	bianco	196005 10	445,38
<i>Bahia LED</i>	A ⁺	bianco	196005L 10	621,85
<i>Bahia LED dimmable</i>	A ⁺	bianco	196005LD 10	671,43
<i>Bahia mini fluo</i>	A ⁺ , A	bianco	1960052 10	247,90
<i>Bahia mini fluo dimmable</i>	A ⁺ , A	bianco	1960052D 10	310,92
<i>Bahia mini LED</i>	A ⁺	bianco	1960052L 10	399,16
<i>Bahia mini LED dimmable</i>	A ⁺	bianco	1960052LD 10	449,58

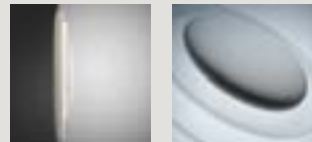
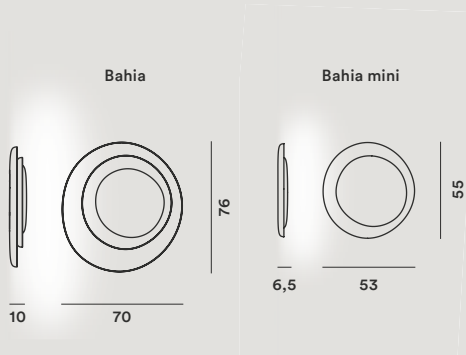

Big Bang

Enrico Franzolini con Vicente Garcia Jimenez, 2005



	energy cl.	colours	code	vat excluded
<i>Big Bang</i>	A ⁺ , A, C	bianco	151005 10	428,57
		rosso	151005 63	445,38
Spare parts:				
<i>Set lampshades Big Bang</i>		bianco	151S05 10	253,78
		rosso	151S05 63	270,59
<i>Halogen protection glass</i>			PIREX94/4/I	21,01

Methacrylate and lacquered metal

LED retrofit or Halo
1x120W R7s

⊕ CE IP 20

Colours: bianco, rosso



Special colours
on request

Weight:
net kg 3,00

Halo, LED retrofit
light bulbs not included
→ specifications p. 190

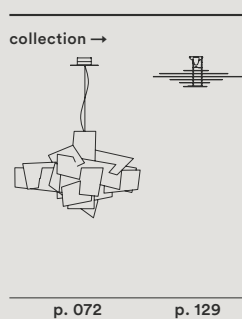
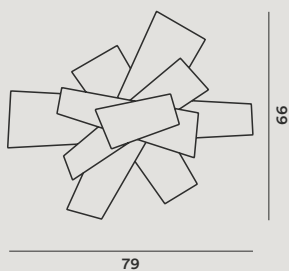

Birdie

Ludovica + Roberto
Palomba, 2012



Polycarbonate, coated steel
and metal

Birdie
LED retrofit or Fluo
1x25W E27
Halo 1x70W E27

⊕ ⚡ CE IP 20

**Birdie with Integrated touch
dimmer**
Dimmerable LED retrofit or
Halo 1x70W E27
minimum Halo bulb output
40W

⊕ CE IP 20

	energy cl.	colours	code	vat excluded
Birdie	A ⁺ , A	bianco	2210052 10	215,13
		grigio	2210052 25	
		arancio	2210052 53	
		amaranto	2210052 65	
Birdie with touch dimmer	A ⁺ , A	bianco	2210052DM 10	267,23
		grigio	2210052DM 25	
		arancio	2210052DM 53	
		amaranto	2210052DM 65	
Spare parts:				
Lampshade Birdie		bianco	221S002 10	46,22
		grigio	221S002 25	
		arancio	221S002 53	
		amaranto	221S002 65	

Colours: bianco, grigio,
arancio, amaranto

Weight:
net kg 1,60

Halo, Fluo, LED retrofit
light bulbs not included
→ specifications p. 190



Special colours
on request

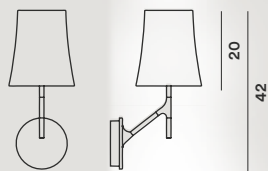

17

24

collection →

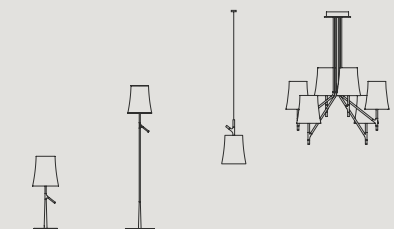

p.017

p. 043

p. 071

p. 130

Bit

Ferruccio Laviani, 1993



Silkscreen-printed glass and lacquered metal

LED retrofit or Fluo
1x12W E14
Halo 1x46W E14



	energy cl.	colours	code	vat excluded
Bit 1	A ⁺ , A	rosso	0430051	195,80
		bianco	0430051 10	
Bit 2	A ⁺ , A	blu	0430052	195,80
		bianco	0430052 10	
Bit 3	A ⁺ , A	bianco	0430053	195,80
Bit 4	A ⁺ , A	verde	0430054	195,80
		bianco	0430054 10	
Bit 5	A ⁺ , A	arancio	0430055	195,80
		bianco	0430055 10	

Spare parts:

Glass Bit 1	bianco	043S00/1 10	50,42
	rosso	043S00/1 63	
Glass Bit 2	bianco	043S00/2 10	50,42
	blu	043S00/2 33	
Glass Bit 3	bianco	043S00/3 10	50,42
Glass Bit 4	bianco	043S00/4 10	50,42
	verde	043S00/4 40	
Glass Bit 5	bianco	043S00/5 10	50,42
	arancio	043S00/5 52	

Colours: bianco, colorato
(1 rosso, 2 blu, 3 bianco,
4 verde, 5 arancio)



Weight:

Bit 1
net kg 1,70
Bit 2
net kg 1,20
Bit 3
net kg 1,80
Bit 4
net kg 1,25
Bit 5
net kg 1,35

Halo, Fluo, LED retrofit
light bulbs not included
→ specifications p. 190

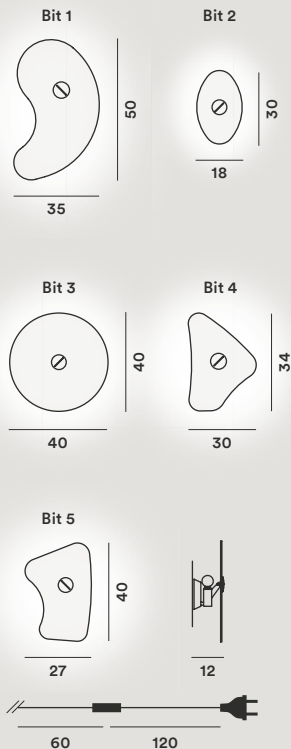

collection →



p. 054



Blob S

Karim Rashid, 2002



Rotational moulded
polyethylene

Fluo 1x24W 2G11

☐ C€ IP 20

	energy cl.	colours	code	vat excluded
<i>Blob S</i>	A ⁺ , A	bianco	124035 10	184,87
Spare parts:				
<i>Lampshade Blob S</i>	A ⁺ , A	bianco	124S00 10	62,18

Colours: bianco



Weight:
net kg 1,10

Fluo light bulbs
not included
→ specifications p. 190

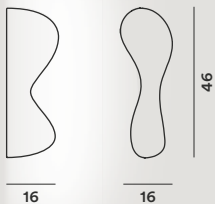

collection →



p. 136



Caboche

Patricia Urquiola
con Eliana Gerotto, 2006



PMMA, blown glass and
chromed metal

LED retrofit or Halo
1x120W R7s

⊕ CE IP 20

	energy cl.	colours	code	vat excluded
<i>Caboche media</i>	A ⁺ , A, C	trasparente	138005 16	584,04
		giallo oro	138005 52	
<i>Caboche piccola</i>	A ⁺ , A, C	trasparente	138025 16	302,52
		giallo oro	138025 52	
Spare parts:				
<i>Kit 10 spheres Caboche</i>		trasparente	138KIT 10SF16	39,50
		giallo oro	138KIT 10SF52	
<i>Kit 15 prongs 3 spheres Caboche media</i>			138KIT 15M3	29,41
<i>Kit 15 prongs 4 spheres Caboche media</i>			138KIT 15M4	29,41
<i>Kit 3+3 prongs 3-4 spheres Caboche media</i>			138KIT-R2	21,01
<i>Kit 10 prongs, 3 spheres Caboche piccola</i>			138KIT 10P3	24,37
<i>Kit 10 prongs 4 spheres Caboche piccola</i>			138KIT 10P4	24,37
<i>Kit 3+3 prongs 3-4 spheres Caboche piccola</i>			138KIT2-R2	17,65
<i>Glass Caboche</i>			138V052/1	63,87
<i>Halogen protection glass</i>			PIREX94/4/1	21,01

Colours: trasparente,
giallo oro

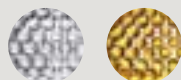

Special colours
on request

Weight:
Caboche media
net kg 4,50

Caboche piccola
net kg 2,60

Halo, LED retrofit
light bulbs not included
→ specifications p. 190

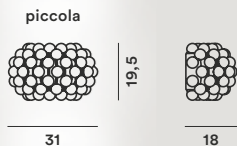
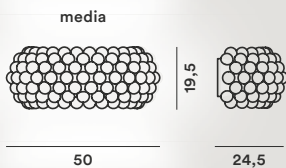

collection →

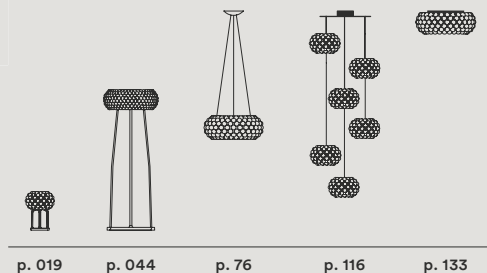

Circus

Defne Koz, 1994



	energy cl.	colours	code	vat excluded
<i>Circus grande</i>	A ⁺ , A	bianco	0460081 11	420,17
<i>Circus piccola</i>	A ⁺ , A	bianco	046008 11	267,23

Spare parts:

<i>Glass Circus grande</i>	bianco	046S001 11	269,75
<i>Glass Circus piccola</i>	bianco	046S00 11	150,42

Blown glass, nickel-plated or coated metal

Circus grande
LED retrofit or Fluo
4x12W E27
Halo 4x46W E27

Circus piccola
LED retrofit or Fluo
4x8W E14
Halo 4x30W E14



Colours: bianco



Special colours on request

Weight:
Circus grande
net kg 4,70

Circus piccola
net kg 2,10

Halo, Fluo, LED retrofit light bulbs not included
→ specifications p. 190

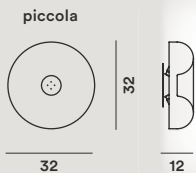
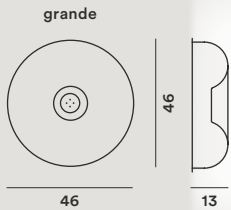

collection →



p. 134

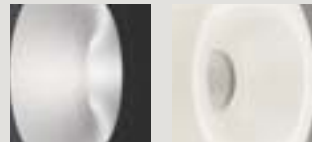

Double

Valerio Bottin, 1996



	energy cl.	colours	code	vat excluded
<i>Double</i>	A ⁺ , A	bianco	069005 11	268,90
		avorio	069005 51	
Spare parts:				
<i>Glass Double</i>		bianco	069S00 11	157,98
		avorio	069S00 51	

Blown glass and coated metal

LED retrofit or Fluo
2x20W E27
Halo 2x77W E27

⊕ CE IP 20

Colours: bianco, avorio



Special colours
on request

Weight:
netto kg 2,00

Halo, Fluo, LED retrofit
light bulbs not included
→ specifications p. 190

Tecnico — 2018



26



13

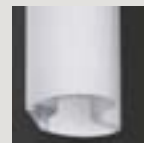

Ellepi

Alessandra Matilde, 2003



Methacrylate and coated
metal

Fluo 1x55W 2GX13

⊕ CE IP 20

	energy cl.	colours	code	vat excluded
<i>Ellepi</i>	A ⁺ , A	bianco	128005 10	399,16
Spare parts:				
<i>Lampshade Ellepi</i>		bianco	128S00 10	205,88

Colours: bianco



Special colours
on request

Weight:
netto kg 4,30

Fluo light bulbs
not included
→ specifications p. 190

collection →

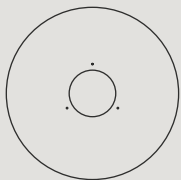

74

6,5

p. 135

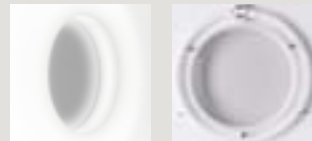

Fields

Vicente Garcia Jimenez,
2007



Methacrylate, coated
aluminium and
polycarbonate

Fields 1
Fluo 1x80W G5

Fields 2
Fluo 1x54W G5

Fields 3
Fluo 1x39W G5

Horizontal and vertical use

Fields
Fluo 1x80W G5 + 1x54W G5
+ 1x39W G5

⊕ CE IP 20

	energy cl.	colours	code	vat excluded
<i>Fields</i>	A+, A	bianco	174005 10	1.842,85
		arancio	174005 63	
<i>Fields 1</i>	A+, A	bianco	1740051 10	571,43
		arancio	1740051 63	
<i>Fields 2</i>	A+, A	bianco	1740052 10	670,58
		arancio	1740052 63	
<i>Fields 3</i>	A+, A	bianco	1740053 10	600,84
		arancio	1740053 63	
Spare parts:				
<i>Set lampshades Fields 2</i>		bianco	174S002 10	87,39
		arancio	174S002 63	
<i>Set lampshades Fields 3</i>		bianco	174S003 10	84,87
		arancio	174S003 63	

Colours:
bianco, arancio



Special colours
on request

Weight:
Fields 1
net kg 6,00

Fields 2
net kg 6,50

Fields 3
net kg 5,80

Fields
net kg 18,30

Fluo light bulbs
not included
→ specifications p. 190

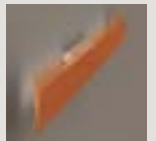
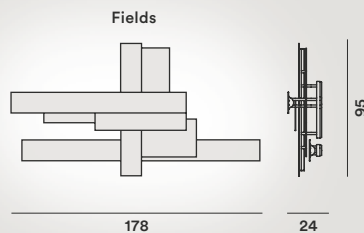
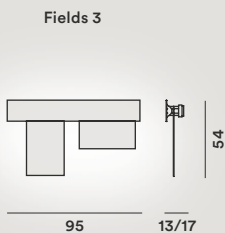
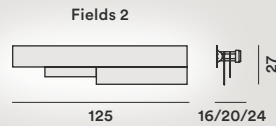
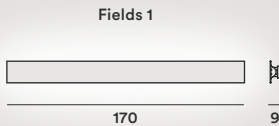

Filo

Andrea Anastasio, 2017



	energy cl.	colours	code	vat excluded
<i>Filo</i>	A++	amethyst queen	289005-01	336,13
		eastern coral	289005-02	
		teodora	289005-04	
		emerald king	289005-08	

Porcelain, textile cable, blown glass and varnished metal

LED retrofit included
4W G9 3000°K
400 lm CRI>80



Colours:

Weight:
net kg 2,40

Amethyst Queen

Eastern Coral

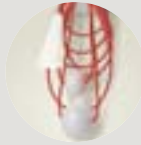

Teodora

Emerald King

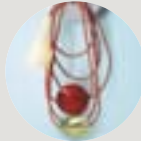
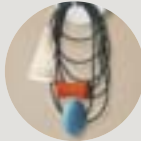

collection →

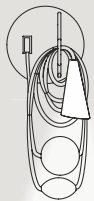

23



16

57



p. 022



p. 046



Folio

Carlo Urbinati e Alessandro Vecchiato, 1990

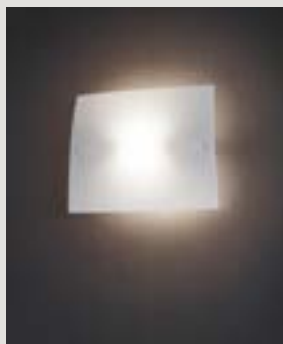

	energy cl.	colours	code	vat excluded
<i>Folio grande halogen</i>	A ⁺ , A, C	bianco	0190051 10	336,13
<i>Folio piccola halogen</i>	A ⁺ , A, C	bianco	019005-R1 10	252,10

Spare parts:

<i>Glass Folio grande</i>	bianco	019S001 10	210,92
<i>Glass Folio piccola</i>	bianco	019S00 10	131,09
<i>Halogen protection glass</i>	bianco	PIREX94/4/I	21,01

Blown acid-etched glass and coated metal

LED retrofit or Halo
1x120W R7s



Colours: bianco



Special colours
on request

Weight:
Folio grande
net kg 2,17

Folio piccola
net kg 1,48

Halo, LED retrofit
light bulbs not included
→ specifications p. 190

grande

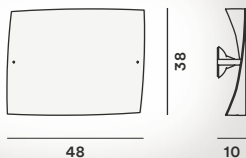

collection →



piccola

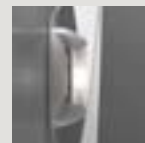
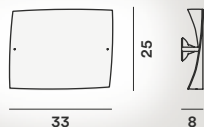

Gregg

Ludovica + Roberto
Palomba, 2007



	energy cl.	colours	code	vat excluded
<i>Gregg media</i>	A ⁺ , A,	bianco	168005 10	298,32
<i>Gregg MIDI</i>	A	bianco	1680053-10	234,45
<i>Gregg piccola</i>	A ⁺ , A, C	bianco	1680052 10	144,54
Spare parts:				
<i>Glass Gregg media</i>		bianco	168S00 10	171,43
<i>Glass Gregg MIDI</i>		bianco	168RV003-10	89,29
<i>Glass Gregg piccola</i>		bianco	168S00210	58,82

Blown acid-etched glass and coated metal

Colours: bianco

Weight:
Gregg media
net kg 2,90

Halo, Fluo, LED retrofit
light bulbs not included
→ specifications p. 190

Gregg media
LED retrofit or Fluo
1x25W E27
Halo 1x150W E27



Gregg MIDI
nett kg 1,60

Gregg piccola
net kg 0,60

Gregg MIDI
LED included COB 8,5W
2700° K 700 lm CRI>90
Dimmable with
TRIAC technology



Gregg piccola
LED retrofit or Halo
1x20W G9



media

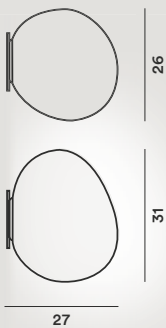

MIDI



piccola



collection →

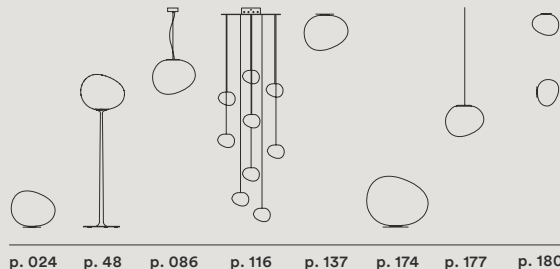

Havana

Joseph Forakis, 1993



Injection moulded polyethylene and coated metal

LED retrofit or Fluo
1x25W E27
Halo 1x116W E27

⊕ CE IP 20

	energy cl.	colours	code	vat excluded
<i>Havana</i>	A ⁺ , A	bianco	0400072-R1 10	216,81
Spare parts:				
<i>Set lampshades Havana</i>		bianco	040S00 10	78,99

Colours: bianco



Special colours on request

Weight:
net kg 1,90

Halo, Fluo, LED retrofit light bulbs not included
→ specifications p. 190

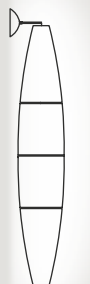

collection →

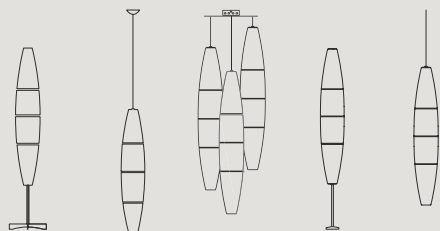

Innerlight

Simon Pengelly, 2012



	energy cl.	colours	code	vat excluded
<i>Innerlight</i>	A ⁺ , A	bianco	233005 10	411,76
<i>Innerlight dimmable</i>	A ⁺ , A	bianco	233005DM 10	475,63

Translucent polycarbonate
and coated or acid-etched
steel

Fluo 2x36W 2G11

Dimmable version
Possible configurations:
On-Off/Push/DALI

⊕ CE IP 20

Colours: bianco



Weight:
net kg 5,00

Fluo light bulbs
not included
→ specifications p. 190

LED and dimming
→ specifications p. 189



77



11

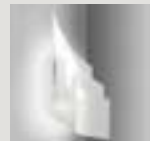

Kite

Marc Sadler, 2003



Fiberglass fabric with carbonium thread

LED retrofit or Fluo
3x12W E14
Halo 3x30W E14

⊕ CE IP 20

	energy cl.	colours	code	vat excluded
<i>Kite</i>	A ⁺ , A	nero	1110051 20	268,91
Spare parts:				
<i>Lampshade Kite</i>		nero	111S005 20	199,16

Colours: nero



Weight:
net kg 0,50

Halo, Fluo, LED retrofit
light bulbs not included
→ specifications p. 190

Tecnico — 2018

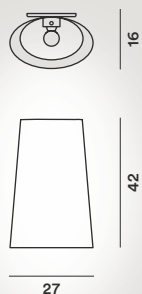

27

collection →

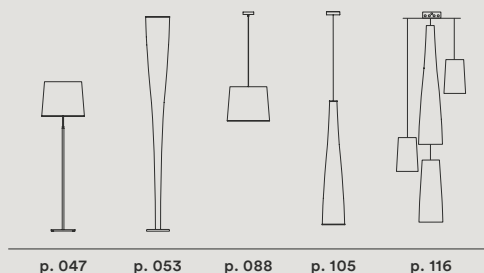

Lake

Lucidi e Pevere, 2015



	energy cl.	colours	code	vat excluded
<i>Lake</i>	A	avorio	257005 50	415,96
		rosso	257005 63	

Injection moulded ABS.

Colours: avorio, rosso

Weight:
net kg 5,50LED and dimming
→ specifications p. 189

LED included
12,7W Acrich 3000° K 850 lm
CRI>80 67 lm/W
Dimmable only with Seoul-
Acrich LED compatible
modules

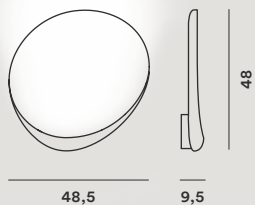
Le Soleil

Vicente Garcia Jimenez,
2013



	energy cl.	colours	code	vat excluded
<i>Le Soleil</i>	A ⁺ , A	bianco	181005 10	278,99
		rosso	181005 63	
<i>Le Soleil dimmable</i>	A ⁺ , A	bianco	181005DM 10	348,73
		rosso	181005DM 63	
Spare parts:				
<i>Set lampshades Le Soleil</i>		bianco	181S005 10	111,76
		rosso	181S005 63	

Injection moulded varnished polycarbonate and coated metal

Colours: bianco, rosso

Weight:
net kg 1,60

Fluo light bulbs
not included
→ specifications p. 190



Fluo 2x26W G24-q3

Dimmable version
Possible configurations:
On-Off/Push/DALI

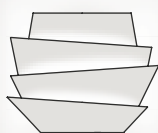

37

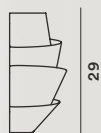

14

collection →



p. 091



Lumiere XXL + XXS

Rodolfo Dordoni, 2010



Blown glass and lacquered metal

Lumiere XXL LED

LED included
55W 2700°K
4700 lm CRI>80
Dimmable with TRIAC technology

Lumiere XXL fluo

Fluo 1x40W + 1x22W 2GX13
dimmerabile 1x55W 2GX13
Dimmable version
Possible configurations:
On-Off/Push/DALI

Lumiere XXS LED

LED included
30W 2700°K
2200 lm CRI>80
Dimmable with TRIAC technology

Lumiere XXS fluo

Fluo 2x18W G24q-2

⊕ CE IP 20

	energy cl.	colours	code	vat excluded
<i>Lumiere XXL LED</i>	A ⁺	bianco	191005L-11	369,75
		grigio	191005L-24	411,76
		marrone	191005L-55	
<i>Lumiere XXL fluo</i>	A ⁺ , A	bianco	191005 11	361,34
<i>Lumiere XXL fluo dimm.</i>	A ⁺ , A	bianco	191005DM 11	433,61
<i>Lumiere XXS LED</i>	A ⁺	bianco	1910052L-11	310,92
		grigio	1910052L-24	331,93
		marrone	1910052L-55	
<i>Lumiere XXS fluo</i>	A ⁺ , A	bianco	1910052 11	308,40
Spare parts:				
<i>Glass Lumiere XXL</i>		bianco	191S0051 11	202,52
		grigio	191S0051-24	244,53
		marrone	191S0051-55	
<i>Glass Lumiere XXS</i>		bianco	191S0052 11	146,22
		grigio	191S0052-24	167,23
		marrone	191S0052-55	

Colours: bianco, grigio
freddo, marrone freddo

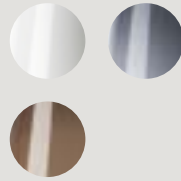

Special colours
on request

Weight:
Lumiere XXL
net kg 3,40

Lumiere XXS
net kg 1,80

Fluo light bulbs
not included
→ specifications p. 190

LED and dimming
→ specifications p. 189

Lumiere XXL

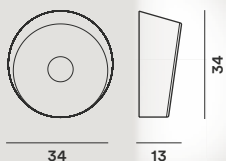

Lumiere XXS

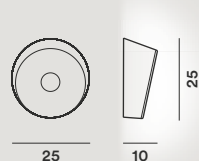

collection →

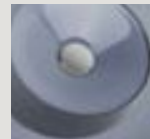
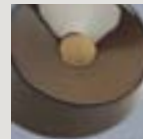
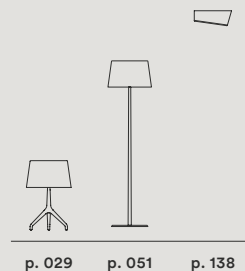

Nuage

Philippe Nigro, 2012



Injection-moulded polycarbonate and batch-dyed ABS

Fluo 1x40W + 1x22W 2GX13
Dimmable 1x55W 2GX13

Dimmable version
Possible configurations:
On-Off/Push/DALI

Usable in composition



	energy cl.	colours	code	vat excluded
Nuage	A ⁺ , A	bianco	243005 10	406,72
		rosso*	243005 63	
Nuage dimmable	A ⁺ , A	bianco	243005DM 10	459,66
		rosso*	243005DM 63	
Accessories				
Lamp connection set		40+22W	243KIT	26,05
		dimmable	243KIT DM	40,34
Spare parts:				
Set lampshades Nuage		bianco	243S00 10	280,67
		rosso	243S00 63	

* Limited stock available

Colours: bianco,



rosso*

* Limited stock available



Weight:
net kg 3,20

Fluo light bulbs
not included
→ specifications p. 190

LED and dimming
→ specifications p. 189

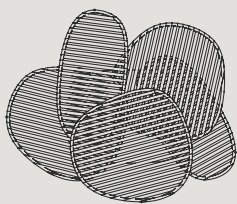

63

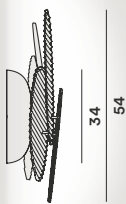

16

collection →



p. 139

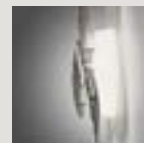

Rituals

Ludovica + Roberto
Palomba, 2015



Blown satin glass and
lacquered metal

Rituals 1-3
LED retrofit or Fluo
1x15W E27
Halo 1x70W E27

Rituals 1-3 doppia
LED retrofit or Fluo
2x15W E27
Halo 2x70W E27

⊕ CE IP 20

	energy cl.	colours	code	vat excluded
<i>Rituals 1</i>	A ⁺ , A	bianco	2440051 10	374,79
<i>Rituals 3</i>	A ⁺ , A	bianco	2440053 10	326,89
<i>Rituals 1 doppia</i> on request	A ⁺ , A	bianco	24400512 10	693,28
<i>Rituals 3 doppia</i> on request	A ⁺ , A	bianco	24400532 10	600,85
Spare parts:				
<i>Glass Rituals 1</i>		bianco	244S001 10	221,85
<i>Glass Rituals 3</i>		bianco	244S003 10	166,39

Colours: bianco



Weight:
Rituals 1
net kg 4,80

Rituals 3
net kg 2,40

Rituals 1 doppia
net kg 8,80

Rituals 3 doppia
net kg 6,00

Halo, Fluo, LED retrofit
light bulbs not included
→ specifications p. 190

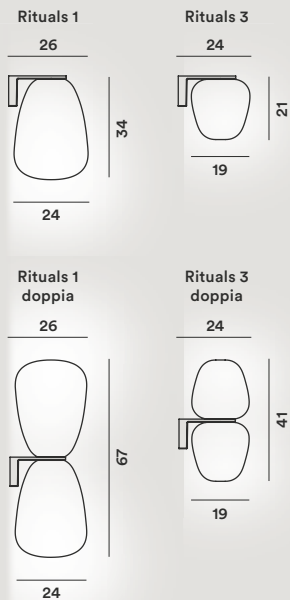

collection →

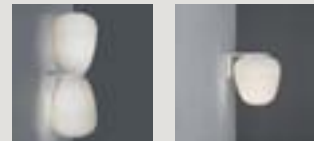
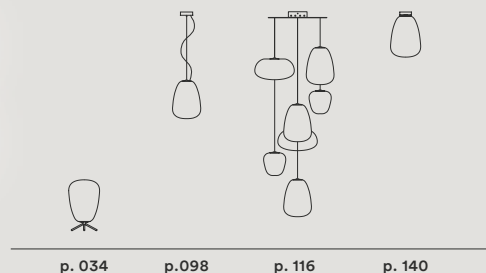

Satellite

Eugeni Quitllet, 2017



	energy cl.	colours	code	vat excluded
Satellite	A ⁺	bianco/trasp.	285025-15	331,93

Blown glass and lacquered aluminium

Colours:
bianco / trasparente

Weight:
net kg 2,00

LED included
6W 2700°K 504 lm CRI>80



Dimmable with TRIAC
technology

⊕ CE IP 20

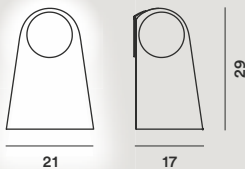

collection →



p. 033

p. 100

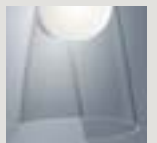

Tivu

Joseph Forakis, 2011

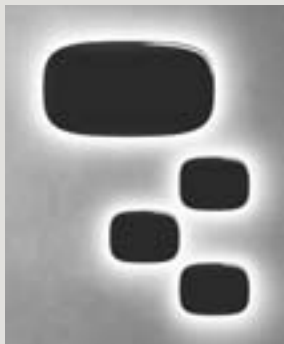

	energy cl.	colours	code	vat excluded
<i>Tivu grande</i>	A ⁺ , A	bianco*	207005 10	201,68
		nero*	207005 20	
<i>Tivu piccola</i>	A ⁺ , A, C	bianco*	2070052 10	111,76
		nero*	2070052 20	

* Limited stock available

Injection moulded polycarbonate

Tivu grande
Fluo 2x18W 2G11
Horizontal and vertical use



Tivu piccola
LED retrofit or Halo
1x20W G9



Colours: bianco*, nero*
* Limited stock available



Weight:
Tivu grande
net kg 1,30

Tivu piccola
net kg 0,30

Halo, Fluo, LED retrofit
light bulbs not included
→ specifications p. 190

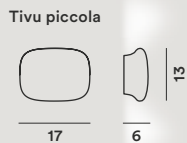
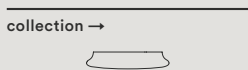
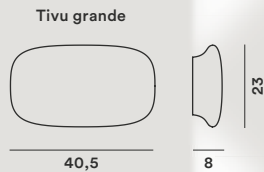

Tress

Marc Sadler, 2011



Coated fibreglass-based composite material and coated metal

LED retrofit or Halo
1x120W R7s



	energy cl.	colours	code	vat excluded
<i>Tress grande</i>	A ⁺ , A, C	bianco	182005 10	394,96
		nero	182005 20	
<i>Tress piccola</i>	A ⁺ , A, C	bianco	1820052 10	357,15
		nero	1820052 20	
Spare parts:				
<i>Lampshade Tress grande</i>		bianco	182S005 10	254,62
		nero	182S005 20	
<i>Lampshade Tress piccola</i>		bianco	182S0052 10	216,81
		nero	182S0052 20	
<i>Halogen protection glass</i>			PIREX94/4/1	21,01

Colours: bianco, nero



Special colours
on request

Weight:
Tress grande
net kg 1,10

Tress piccola
net kg 1,00

Halo, LED retrofit
light bulbs not included
→ specifications p. 190

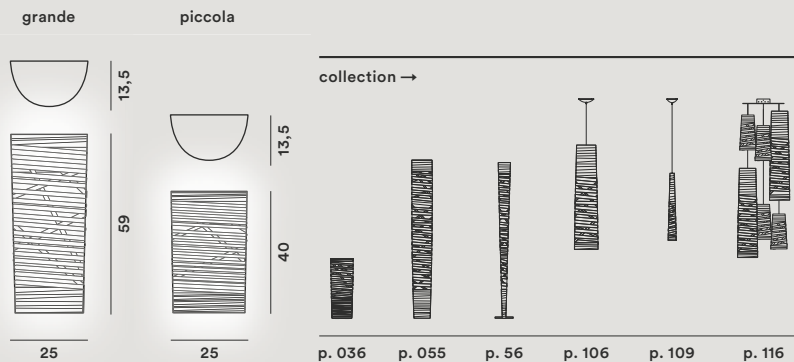

Tutù

Valerio Bottin, 2001



Blown glass, metal and aluminium

LED retrofit or Fluo
2x12W E14
Halo 2x46W E14

⊕ CE IP 20

	energy cl.	colours	code	vat excluded
<i>Tutù</i>	A ⁺ , A	bianco	114005I 11	184,87
		avorio	114005I 51	

Spare parts:

<i>Glass Tutù</i>		bianco	114S005 11	86,55
		avorio	114S005 51	

Colours: bianco, avorio

Weight:
net kg 0,80

Halo, Fluo, LED retrofit
light bulbs not included
→ specifications p. 190



Special colours
on request

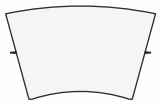

29



18

13





Esterno, *Outdoor*

- 174 **Gregg**
outdoor terra
- 175 **Havana**
outdoor terra
- 176 **Solar**
outdoor terra
- 177 **Gregg**
outdoor sospensione
- 178 **Havana**
outdoor sospensione
- 179 **Uto**
sospensione
- 180 **Gregg MIDI**
parete / soffitto

Gregg outdoor

terra

Ludovica + Roberto
Palomba, 2011



Rotational moulded
polyethylene and coated
metal

X-large / grande
LED retrofit or Fluo
1x25W E27

media
LED retrofit or Fluo
1x15W E27

CE IP 65 - IP 44

	energy cl.	colours	code	vat excluded
<i>Gregg outdoor X-large</i>	A ⁺ , A	bianco	218003 10	327,73
<i>Gregg outdoor grande</i>	A ⁺ , A	bianco	218013 10	249,58
<i>Gregg outdoor media</i>	A ⁺ , A	bianco	218023 10	192,44
Spare parts:				
<i>Lampshade Gregg outdoor X-large</i>		bianco	218S001 10	178,99
<i>Lampshade Gregg outdoor grande</i>		bianco	218S00 10	100,84
<i>Lampshade Gregg outdoor media</i>		bianco	218S002 10	63,03

Colours: bianco



Weight:
X-large
net kg 4,30

grande
net kg 3,60

media
net kg 1,60

Fluo, LED retrofit
light bulbs not included
→ specifications p. 190

X-large

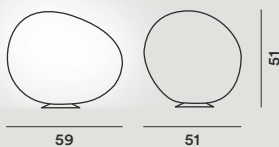

grande

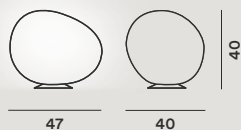

media



X-large / grande / media



collection →

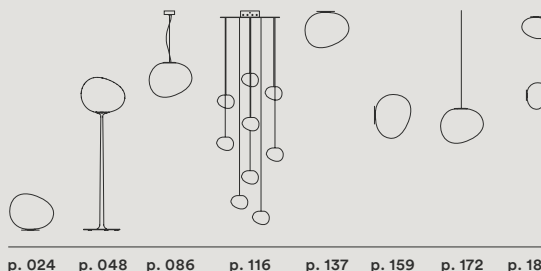

IP 44



IP 65



Havana outdoor

terra

Jozeph Forakis, 2005



Rotational moulded polyethylene and coated metal

LED retrofit or Fluo
1x15W E27
Halo 1x46W E27

CE IP 65 - IP 44

	energy cl.	colours	code	vat excluded
<i>Havana out. terra undergr. base</i>	A+, A	bianco	150003 10	651,26
<i>Havana out. terra stake mounted</i>	A+, A	bianco	1500031 10	546,21
<i>Havana out. terra base</i>	A+, A	bianco	1500032 10	584,03
<i>Havana out. terra bassa undergr. base</i>	A+, A	bianco	150004 10	634,45
<i>Havana out. terra bassa stake mounted</i>	A+, A	bianco	1500041 10	529,41
<i>Havana out. terra bassa base</i>	A+, A	bianco	1500042 10	567,23

Spare parts:

<i>Lampshade Havana outdoor</i>	bianco	150S00 10	155,46
<i>Underground base</i>		150S032	119,33
<i>Stake mounted</i>		150S031	109,24
<i>Base</i>		150S033-R1	147,06

Colours: bianco



Special colours on request

Weight:
Underground base
net kg 5,50

Stake mounted
net kg 5,20

Base
net kg 10,10

Halo, Fluo, LED retrofit light bulbs not included
→ specifications p. 190

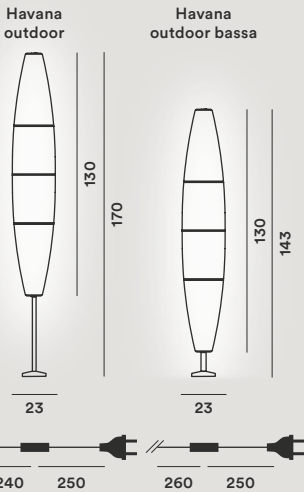
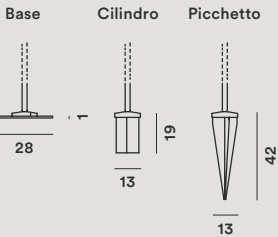

collection →

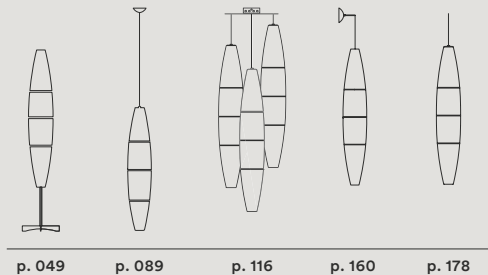

IP 44



IP 65



base



cilindro

picchetto

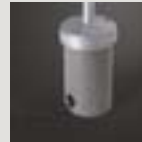

Solar

Jean Marie Massaud, 2011



	energy cl.	colours	code	vat excluded
<i>Solar</i>	A ⁺ , A	marrone	228003M	747,90
Spare parts:				
<i>Lampshade Solar</i>		bianco	228S1110	229,41
<i>Top disk Solar</i>		marrone	228S101M-R1	344,54

Rotational moulded polyethylene, porcelain stoneware top shelf

LED retrofit or Fluo
1x25W E27

Reclinable up to 15°

☐ CE ⚡ IP 65 - IP 44

Colours: marrone



Weight:
net kg 11,70

Fluo, LED retrofit light bulbs not included
→ specifications p. 190

Tecnico — 2018

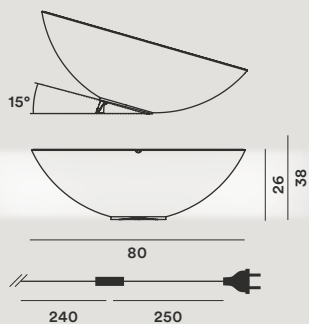

IP 44

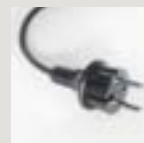

IP 65

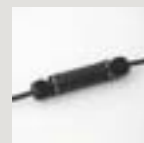

Gregg outdoor

sospensione

Ludovica + Roberto Palomba,
2011



	energy cl.	colours	code	vat excluded
<i>Gregg outdoor X-large</i>	A ⁺ , A	bianco	218007 10	306,72
<i>Gregg outdoor grande</i>	A ⁺ , A	bianco	218017 10	228,57
<i>Gregg outdoor media</i>	A ⁺ , A	bianco	218027 10	183,20
<i>Gregg outdoor X-large h. 10 m</i> •	A ⁺ , A	bianco	218007/10-10	385,15
<i>Gregg outdoor grande h. 10 m</i> •	A ⁺ , A	bianco	218017/10-10	307,00
<i>Gregg outdoor media h. 10 m</i> •	A ⁺ , A	bianco	218027/10-10	261,63

Spare parts:

<i>Lampshade Gregg outdoor X-large</i>	bianco	218S001 10	178,99
<i>Lampshade Gregg outdoor grande</i>	bianco	218S00 10	100,84
<i>Lampshade Gregg outdoor media</i>	bianco	218S002 10	63,03

Rotational moulded polyethylene and coated metal

X-large / grande
LED retrofit or Fluo
1x25W E27

media
LED retrofit or Fluo
1x15W E27

Canopy not included

☐ CE ⚡ IP 65 - IP 44

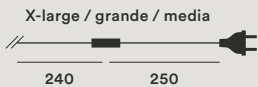
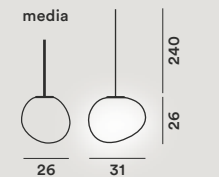
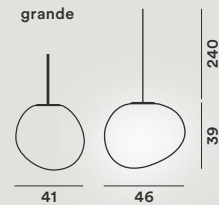
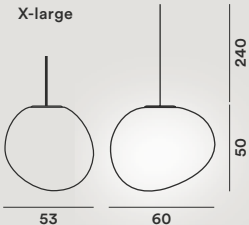

Colours: bianco



Weight:
X-large
net kg 3,70

grande
net kg 3,00

media
net kg 1,40

•
H. 10 m on demand:
lead times to be
checked with the sales
department

Fluo, LED retrofit light
bulbs not included
→ specifications p. 190

collection →



IP 44

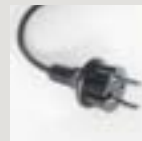

IP 65

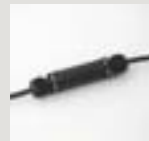

Havana outdoor

sospensione

Jozeph Forakis, 2005



	energy cl.	colours	code	vat excluded
<i>Havana outdoor</i>	A+, A	bianco	150007 10	347,06
<i>Havana outdoor h. 10 m •</i>	A+, A	bianco	150007 10SP10	468,05

Spare parts:

<i>Lampshade Havana Outdoor</i>	bianco	150S00 10	155,46
---------------------------------	--------	-----------	--------

Rotational moulded polyethylene and coated metal

LED retrofit or Fluo
1x15W E27
Halo 1x46W E27

Canopy not included

☐ CE ◀ IP 65 - IP 44

Colours: bianco



Weight:
net kg 3,00

Halo, Fluo, LED retrofit
light bulbs not included
→ specifications p. 190

•
H. 10 m on demand:
lead times to be
checked with the
sales department

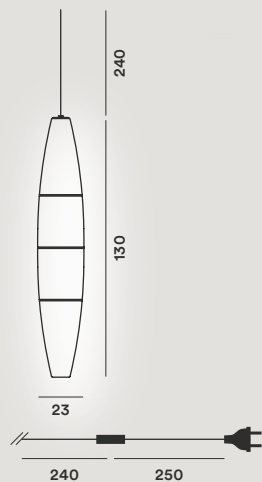

collection →

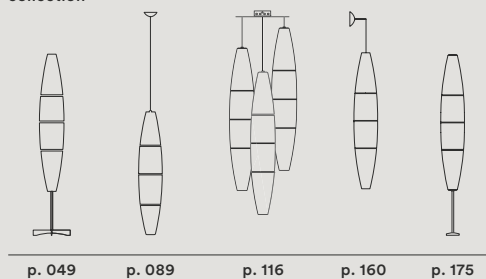

IP 44

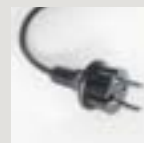

IP 65



Uto

Lagranja Design, 2005



	energy cl.	colours	code	vat excluded
Uto	A ⁺ , A	bianco	142000 10	348,74
		giallo	142000 50	
		arancio	142000 53	

Thermoplastic elastomer and polycarbonate

LED retrofit or Fluo
1x15W E27

Switch inside the flexible tube

☐ CE ⚡ IP 65 - IP 44

Colours: bianco, giallo, arancio



Special colours on request

Weight:
net kg 2,00

Fluo, LED retrofit light bulbs not included
→ specifications p. 190

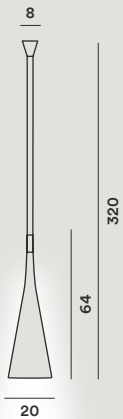

collection →

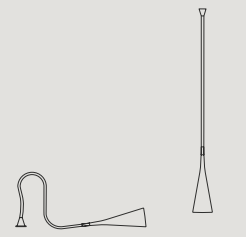

p. 038

p. 114



Gregg MIDI

Ludovica + Roberto
Palomba, 2017



Blown acid-etched glass and coated metal

LED included COB 8,5W
2700° K 700 lm CRI>90
Dimmable with TRIAC technology

⊕ CE IP 44



	energy cl.	colours	code	vat excluded
<i>Gregg MIDI</i>	A	bianco	1680053-10	234,45
Spare parts:				
<i>Glass Gregg MIDI</i>		bianco	168RV003-10	89,29

Colours: bianco



Special colours on request

Weight:
net kg 1,60

Tecnico — 2018

parete

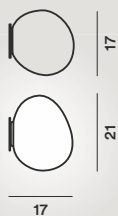

soffitto

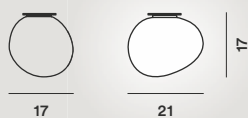

collection →

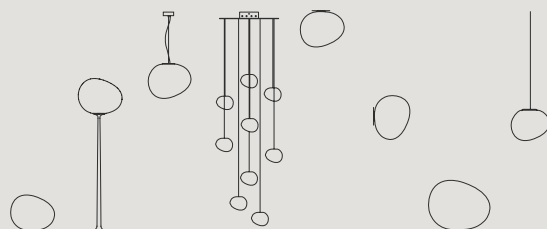

p. 024 p. 048 p. 086 p. 116 p. 137 p. 159 p. 174 p. 177

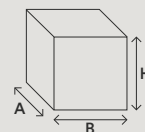
Packing

Model	Version	Version	N° boxes	Description	net weight kg	gross weight kg	size cm A x B x H	
Allegretto	<i>Assai</i>	sospensione	1	set rodes	8,7	13,0	91x61x29	
			1	frame	2,6	5,0	47x47x34	
	<i>Ritmico</i>	sospensione	1	set rodes	2,7	4,5	66x41x25	
			1	frame	2,4	4,7	47x47x34	
	<i>Vivace</i>	sospensione	1	set rodes	6,4	8,7	84x39x27	
			1	frame	2,7	5,1	47x47x34	
Allegro	<i>Assai</i>	sospensione	1	set rodes	31,0	46,5	187x37x27	
			1	frame	5,0	6,5	43x43x34	
	<i>Ritmico</i>	sospensione	1	set rodes	10,0	11,9	97x53x25	
			1	frame	5,0	6,5	43x43x34	
	<i>Vivace</i>	sospensione	1	set rodes	14,3	16,7	111x44x27	
			1	frame	5,0	6,3	43x43x34	
Anisha	<i>grande</i>	tavolo	1		0,4	1,2	41x29x10	
	<i>piccola</i>	tavolo	1		0,7	1,7	51x37x10	
Aplomb		sospensione	1		1,9	2,9	29x29x51	
	<i>large</i>	sospensione	1	canopy	1	1,1	24X24X9	
			1	frame	2,9	4,6	53X53X29	
	<i>mini</i>	sospensione	1		1,9	2,9	36x19x16	
		terra	1	frame + diffuser	3,2	7,7	28x28x197	
		1	base	5,3	6,5	43x32x8		
	parete	1		1,9	2,8	30x30x52		
Arumi		sospensione	1		1	1,5	23x23x20	
Bahia	<i>Fluo</i>	parete/soffitto	1		3,4	4,5	86x81x16	
	<i>LED</i>	parete	1		4,0	5,1	86x81x16	
	<i>mini</i>	parete/soffitto	1		2,0	4,3	62x62x18	
	<i>mini LED</i>	parete/soffitto	1		2,3	4,6	62x62x18	
Behive		sospensione	1	diffuser	2,3	4,7	49x49x41	
		1	frame	0,8	1,7	25x23x27		
		tavolo	1	diffuser	2,2	4,6	49x49x41	
		1	frame	1,5	2,2	21x21x34		
	Big Bang		parete/soffitto	1	diffuser set	2,0	3,1	89x31x12
			1	frame	1,0	1,4	23x23x9	
<i>Halo</i>		sospensione	1	diffuser set	3,4	4,4	89x31x12	
			1	frame	2,0	3,3	89x31x12	
<i>LED</i>		sospensione	1	diffuser set	3,4	4,4	89x31x12	
			1	frame	4,0	5,5	89x31x12	
Big Bang L		sospensione	1	diffuser set	13,0	15,0	134x41x9	
		1	frame	23,0	30,0	94x39x14		
		1	canopy	2,9	3,3	25x25x14		
Big Bang XL		sospensione	1	diffuser set	23,0	30,0	190x46x15	
		1	frame	12,0	15,0	131x58x50		
		1	canopy	2,9	3,3	25X25X14		
Binic		tavolo	1		0,6	1,3	22x22x14	
Birdie	3	soffitto	3	diffuser	0,4	0,8	23x23x26	
			1	canopy	1,0	2,0	24x24x14	
			1	set 3 arms	1,5	5,1	106x59x18	
	6	soffitto	6	diffuser	0,4	0,8	23x23x26	
			1	canopy	1,2	2,0	24x24x14	
			2	set 3 arms	1,5	5,1	106x59x18	
	9	soffitto	9	diffuser	0,4	0,8	23x23x26	
			1	canopy	1,4	2,0	24x24x14	
			3	set 3 arms	1,5	5,1	106x59x18	
	6	sospensione	6	diffuser	0,4	0,8	23x23x26	
			1	canopy	1,2	2,0	20x19x20	
			2	set 3 arms	1,5	5,1	106x59x18	
	9	sospensione	9	diffuser	0,4	0,8	23x23x26	
			1	canopy	1,4	2,0	20x19x20	
			3	set 3 arms	1,5	5,1	106x59x18	

Model		Version	N° boxes	Description	net weight kg	gross weight kg	size cm A x B x H	
<i>Birdie</i>	<i>grande</i>	tavolo	1	diffuser	0,7	1,5	30x30x35	
			1	frame	3,3	5,4	79x30x27	
	<i>piccola</i>	tavolo	1	diffuser	0,4	0,8	23x23x26	
			1	frame	1,6	3,0	26x26x53	
	<i>grande</i>	sospensione	1	diffuser	0,7	1,5	30x30x35	
			1	frame	0,7	1,7	20x20x29	
	<i>piccola</i>	sospensione	1	diffuser	0,4	0,8	23x23x26	
			1	frame	0,3	0,6	18x18x26	
			lettura	1	diffuser	0,7	1,5	30x30x35
				1	frame	3,6	7,8	159x29x27
		parete	1	diffuser	0,4	0,8	23x23x26	
			1	frame	1,2	2,5	50x20x29	
<i>Bit</i>	1	parete	1	glass	1,1	2,3	61x52x11	
			1	frame	0,6	1,0	19x19x14	
	2	parete	1	glass	0,4	2,3	51x37x11	
			1	frame	0,6	1,0	19x19x14	
	3	parete	1	glass	1,2	2,3	61x52x11	
			1	frame	0,6	1,0	19x19x14	
	4	parete	1	glass	0,6	2,3	51x37x11	
			1	frame	0,6	1,0	19x19x14	
	5	parete	1	glass	0,8	2,3	51x37x11	
			1	frame	0,6	1,0	19x19x14	
<i>Blob S</i>		parete/soffitto	1	diffuser	0,6	0,9	48x17x17	
			1	frame	0,5	0,8	48x13x9,5	
<i>Buds</i>	1	sospensione	1	glass	2,9	3,9	32x32x45	
			1	frame	0,7	0,9	19x19x14	
	2	sospensione	1	glass	4,2	7,2	51x51x34	
			1	frame	0,7	0,9	19x19x14	
	3	sospensione	1	glass	2,5	3,5	38x38x33	
			1	frame	0,7	0,9	19x19x14	
	1 LED	sospensione	1	glass	2,5	5,3	32x32x45	
			1	frame	1,3	2,0	28x23x20	
	2 LED	sospensione	1	glass	3,5	5,0	51x51x34	
			1	frame	1,3	2,0	28x23x20	
	3 LED	sospensione	1	glass	2,5	3,5	38x38x33	
			1	frame	1,3	2,0	28x23x20	
	1	tavolo	1	glass	2,9	3,9	32x32x45	
			1	frame	2,0	2,6	17x17x32	
	2	tavolo	1	glass	4,2	7,2	51x51x34	
			1	frame	2,0	2,6	17x17x32	
3	tavolo	1	glass	2,2	4,4	38x38x33		
		1	frame	2,0	2,6	17x17x35		
<i>Caboche</i>	<i>grande Halo</i>	sospensione	1	set sphere	12,1	13,5	51x51x15	
			1	frame	7,5	9,0	69x69x38	
	<i>grande LED</i>	sospensione	1	set sphere	12,1	13,5	51x51x15	
			1	frame	4,9	7,7	69x69x38	
		<i>terra</i>	1	set sphere	12,1	13,5	51x51x15	
			1	frame	10,5	12,4	69x69x52	
				1	set stem	1,3	2,0	155x11x12
	<i>media Halo</i>	sospensione	1	set sphere	6,4	7,2	38x38x14	
			1	frame	3,8	4,9	52x52x28	
	<i>media LED</i>	sospensione	1	set sphere	6,4	7,2	38x38x14	
			1	frame	3,8	5,1	52x52x28	
	<i>media</i>	parete	1	set sphere	2,7	3,5	31x26x15	
			1	frame	1,8	2,6	45x17x38	
			<i>terra</i>	1	set sphere	6,4	7,2	38x38x14
				1	frame	4,4	6,5	51x51x36
				1	set stem	1,0	1,7	155x11x12
	<i>piccola</i>	parete	1	set sphere	1,5	2,2	34x20x11	
			1	frame	1,1	2,0	18x29x32	
			sospensione	1	set sphere	3,2	3,8	47x24x11
				1	frame	1,6	2,0	29x29x38
		tavolo	1	set sphere	3,2	3,8	47x24x11	
			1	frame	2,1	2,5	29x29x51	

Packing

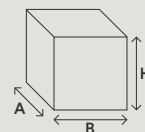

Model	Version	N° boxes	Description	net weight kg	gross weight kg	size cm A x B x H	
<i>Caboche</i>	<i>soffitto</i>	1	set sphere	5,2	6,4	38x35x15	
		1	frame	3,9	4,8	52x52x28	
<i>Caiigo</i>	sospensione	1		2,0	3,0	28x28x36	
<i>Chouchin & reverse</i>	1	sospensione	1	glass	3,7	5,4	51x51x44
		1	frame	0,7	0,8	19x19x14	
	2	sospensione	1	glass	2,2	3,6	34x34x55
		1	frame	0,7	1,0	19x19x14	
	3	sospensione	1	glass	2,9	3,6	38x38x33
		1	frame	0,7	0,8	19x19x14	
	1 LED	sospensione	1	glass	3,7	5,4	51x51x44
		1	frame	1,3	2,0	28x23x20	
	2 LED	sospensione	1	glass	2,2	3,6	34x34x55
		1	frame	1,3	2,0	28x23x20	
	3 LED	sospensione	1	glass	2,9	3,6	38x38x33
		1	frame	1,3	2,0	28x23x20	
<i>Chouchin mini</i>	1	sospensione	1		1,0	1,6	28x22x19
		sospensione	1		1,0	1,7	29x23x20
<i>Circus</i>	<i>grande</i>	parete/soffitto	1	glass	3,0	4,4	51x51x15
		1	frame	1,7	2,7	42x42x17	
	<i>piccola</i>	parete/soffitto	1	glass	1,6	2,0	42x42x17
		1	frame	0,5	0,7	19x19x14	
<i>Doll</i>	tavolo	1		0,7	1,4	22x22x29	
<i>Dolmen</i>	terra	1		11	15,3	52x15x215	
	sospensione	1		11	15,3	52x15x215	
<i>Double</i>	parete	1	diffuser	1,5	1,9	36x36x23	
		1	frame	0,5	0,7	25x15x10	
<i>Ellepi</i>	parete/soffitto	1	diffuser	2,0	3,5	82x72x17	
		1	frame	2,3	3,5	61x51x17	
<i>Esa</i>	<i>grande</i>	tavolo	1	glass	2,0	3,0	52x37x27
		1	frame	1,2	2,0	52x37x27	
	<i>piccola</i>	tavolo	1	glass	1,4	1,7	34x22x23
		1	frame	0,6	1,0	27x22x32	
<i>Fields</i>	1	parete	1		6,0	8,0	177x22x14
		1	diffuser set	1,3	1,5	76x25x4	
	2	parete	1	frame	5,2	7,5	134x25x31
		1	diffuser set	1,3	1,6	60x32x3	
	3	parete	1	frame	4,5	6,1	104x25x25
		1	frame	4,2	4,8	67x30x18	
<i>Filo</i>	tavolo	1	lettura	5,7	8,8	159x34x20	
		1	parete	2,2	3,9	88x32x19	
<i>Folio</i>	<i>grande</i>	parete	1	glass	1,6	3,0	62x52x18
		1	frame	0,6	0,9	56x13x10	
	soffitto	1	glass	1,6	3,0	62x52x18	
		1	frame	0,6	1,1	57x27x11	
	<i>piccola</i>	parete	1	glass	1,0	1,3	38x35x15
		1	frame	0,5	0,8	37x13x10	
<i>Gem</i>	sospensione	1	glass	5,4	7,8	52x52x50	
		1	frame	0,7	0,8	19x19x14	
<i>Giga-Lite</i>	sospensione	1	diffuser	1,5	2,7	57x57x46	
		1	frame	1,0	1,6	29x27x23	
	terra	1	diffuser	1,5	2,7	57x57x46	
		1	frame	8,3	10,9	144x30x14	
<i>Gregg</i>	<i>grande</i>	sospensione	1	glass	5,0	7,0	56x48x47
		1	frame	0,6	0,7	19x19x14	
	<i>grande LED</i>	sospensione	1	glass	5,0	7,0	56x48x47
		1	frame	1,3	2,0	28x23x20	

Model	Version	N° boxes	Description	net weight kg	gross weight kg	size cm A x B x H	
Gregg	tavolo	1	glass	5,0	7,0	56x48x47	
		1	frame	1,8	2,5	23x23x19	
Caboche	grande alta	1	glass	5,0	7,0	56x48x47	
		1	base	7,2	8,3	55x55x3	
		1	frame	2,5	5,0	166x20x20	
	media alta	1	glass	2,5	2,8	38x33x30	
		1	base	7,2	8,3	55x55x3	
		1	frame	2,5	5,0	166x20x20	
	media	parete/soffitto	1	glass	2,5	2,8	38x33x30
			1	frame	0,4	0,7	19x19x18
	media LED	sospensione	1	glass	2,5	2,8	38x33x30
			1	frame	0,6	0,7	19x19x14
tavolo		1	glass	2,5	2,8	38x33x30	
		1	frame	1,3	2,0	28x23x20	
		1	frame	2,5	2,8	38x33x30	
MIDI	tavolo	1	frame	0,8	1,2	19x19x18	
		1	frame	1,4	1,9	26x25x27	
	sospensione	1	frame	1,35	1,85	26x25x27	
		1	parete/soffitto	1,4	1,9	26x25x27	
		1	parete/soffitto	0,6	0,9	27x19x20	
Havana outdoor	sospensione	1	glass	0,7	0,9	27x19x20	
		1	tavolo	0,6	0,9	27x19x20	
	base	1	diffuser	2,0	3,3	25x25x132	
		1	frame	1,0	1,4	64x13x10	
		1	base	6,1	6,5	37x37x3	
	cilindro	1	diffuser	2,0	2,9	107x14x14	
		1	diffuser	2,0	3,3	25x25x132	
		1	underground base	0,5	0,7	15x14x24	
	picchetto	terra	1	frame	3,0	4,0	107x14x14
			1	diffuser	2,0	3,3	25x25x132
terra		1	stake mounted	1,2	1,5	14x13x46	
		1	frame	2,0	2,5	107x14x14	
		1	diffuser	2,0	3,3	25x25x132	
bassa base	terra	1	base	6,1	6,5	37x37x3	
		1	frame	2,0	2,9	107x14x14	
	terra	1	diffuser	2,0	3,3	25x25x132	
		1	underground base	0,5	0,7	15x14x24	
		1	frame	3,0	3,8	107x14x14	
		1	diffuser	2,0	3,3	25x25x132	
bassa picchetto	terra	1	stake mounted	1,2	1,5	14x13x46	
		1	frame	1,5	2,4	107x14x14	
	1	diffuser set	1,3	1,8	49x25x25		
Havana	sospensione/parete	1	frame	0,6	0,8	19x19x14	
		1	diffuser set	1,3	1,8	49x25x25	
Innerlight	parete	1	frame	2,0	3,0	100x29x15	
		1	diffuser set	3,3	4,3	79x20x26	
		1	frame	1,7	3,0	69x30x16	
Jamaica	sospensione	1	diffuser set	2,3	5,9	81x81x27	
		1	frame	3,7	5,4	174x15x20	
Kite	parete	1	diffuser	0,3	1,3	52x37x27	
		1	frame	0,2	0,6	26x16x11	
Kurage	tavolo	1	frame	0,7	3,5	39x39x65	
Lake	parete	1	diffuser	1,3	2,5	58x50x12	
		1	frame	0,4	0,7	18x18x17	
Le Soleil	parete	1	diffuser set	0,8	1,5	38x31x12	
		1	frame	0,8	1,3	28x22x11	
	sospensione	1	diffuser set	4,1	6,0	61x61x23	
		1	frame	1,2	2,2	25x25x33	
Lightweight	sospensione	1	frame	7,6	21,6	113x112x82	
Lightwing	terra	1	frame+diffuser	6,0	14,0	185x38x31	
		1	base	5,0	6,0	30x30x12	
Lumiere	grande	1	glass	1,5	2,1	33x33x26	
		1	frame	0,9	1,4	49x25x25	

Packing

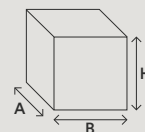

Model	Version	N° boxes	Description	net weight kg	gross weight kg	size cm A x B x H
<i>Lumiere</i>	<i>piccola</i>	tavolo	1 glass	0,6	1,2	26x26x21
			1 frame	0,5	0,8	21x40x19
<i>Lumiere XXL</i>	parete/soffitto		1 glass	1,8	2,1	41x41x20
			1 frame	1,6	3,0	42x42x17
	tavolo	1 glass	4,0	5,3	50x50x37	
<i>Lumiere XXL</i>	lettura	1	1 frame	1,5	2,8	38x38x61
	tavolo	1		2,8	5,0	130x24x5
<i>Lumiere XXS</i>	parete/soffitto		1 glass	1,0	1,6	31x31x17
			1 frame	0,8	1,7	30x30x10
	tavolo	1 glass	1,2	2,3	33x33x26	
		1 frame	0,6	1,7	43x27x27	
	lettura	1 glass	0,4	5,3	50x50x37	
		1 frame	12,5	13,5	155x42x16	
<i>Maki</i>	sospensione	1		0,5	0,8	31x17x15
<i>Mite</i>	terra	1		7,0	11,1	28x28x197
<i>Nuage</i>	parete/soffitto		1 diffuser set	1,4	3,6	71x71x16
			1 frame	1,8	3,0	41x41x13
<i>Orbital</i>	terra		1 glass set	4,1	5,5	71x52x13
			1 frame	6,0	9,7	185x32x27
<i>O-Space</i>	sospensione	1		4,4	6,0	67x55x42
<i>Gregg outdoor</i>	<i>grande</i>	sospensione	1 diffuser	2,3	3,5	50x42x39
			1 frame	0,7	1,5	20x17x26
		terra	1 diffuser	2,3	3,5	50x42x39
			1 frame	1,3	2,3	28x28x15
	<i>media</i>	sospensione	1 diffuser	0,7	1,4	33x28x26
			1 frame	0,7	1,5	20x17x26
		terra	1 diffuser	0,7	1,4	33x28x26
			1 frame	0,9	1,7	21x21x15
	<i>XL</i>	sospensione	1 diffuser	3,0	5,4	63x53x50
			1 frame	0,7	1,2	20x17x26
	terra	1 diffuser	3,0	5,4	63x53x50	
		1 frame	1,3	2,3	28x28x15	
<i>Planet</i>	<i>grande</i>	sospensione	1 diffuser	1,2	4,5	81x81x41
			1 frame	1,4	2,6	29x29x32
	<i>piccola</i>	sospensione	1 diffuser	0,6	2,2	56x56x26
		1 frame	1,4	2,6	29x29x32	
<i>Plass</i>	<i>grande</i>	sospensione	1 diffuser	18,0	24,0	119x79x79
			1 frame	5,0	10,0	129x31x31
<i>Plass</i>	<i>media</i>	sospensione	1 diffuser	2,8	3,5	36x36x52
			1 frame	0,7	1,2	47x22x14
	tavolo	1 diffuser	2,8	3,5	36x36x52	
		1 frame	1,2	2,0	22x22x32	
<i>Polygregg</i>	<i>grande</i>	tavolo	1 diffuser	2,3	3,5	50x42x39
			1 frame	1,3	1,9	28x28x15
	<i>media</i>	tavolo	1 diffuser	0,7	1,4	33x28x26
			1 frame	0,9	1,4	21x21x15
	<i>XL</i>	tavolo	1 diffuser	3,0	5,4	63x53x50
		1 frame	1,3	1,9	28x28x15	
<i>Rituals</i>	1	parete	1 glass	3,4	4,0	33x33x40
			1 frame	1,4	2,0	28x19x18
		soffitto	1 glass	3,4	4,0	33x33x40
			1 frame	0,7	1,1	19x19x21
		sospensione	1 glass	3,4	4,0	33x33x40
			1 frame	0,5	0,8	19x19x14
		tavolo	1 glass	3,4	4,0	33x33x40
			1 frame	0,6	1,2	26x25x18

Model		Version	N° boxes	Description	net weight kg	gross weight kg	size cm A x B x H
<i>Rituals</i>	2	soffitto	1	glass	3,5	4,0	41x41x26
			1	frame	0,7	101	19x19x21
		sospensione	1	glass	3,5	4,0	41x41x26
			1	frame	0,5	0,8	19x19x14
			1	glass	3,5	4,0	41x41x26
	tavolo	1	frame	0,6	1,2	26x25x18	
		1	glass	1,0	1,6	25x25x26	
<i>RitualsXXX</i>	3	parete	1	glass	1,0	1,6	25x25x26
			1	frame	1,4	2,0	28x19x18
		soffitto	1	glass	1,0	1,6	25x25x26
			1	frame	0,7	1,1	19x19x21
		sospensione	1	glass	1,0	1,6	25x25x26
			1	frame	0,5	0,8	19x19x14
	tavolo	1	glass	1,0	1,6	25x25x26	
		1	frame	0,6	1,2	26x25x18	
	XL	tavolo	1	diffuser	5,4	8,4	51x54x50
			1	frame	1,2	2,0	22x22x32
		sospensione	1	diffuser	5,4	8,4	51x54x50
			1	frame	0,6	0,7	19x19x14
XL LED	sospensione	1	diffuser	5,4	8,4	51x54x50	
		1	frame	1,3	2,0	28x23x20	
<i>Satellight</i>		tavolo	1		3,0	3,7	31x31x52
		sospensione	1		5,5	6,3	44x44x54
		parete	1		1,4	2,2	30x30x38
<i>Solar outdoor</i>		terra	1	diffuser	9,4	13,7	87x87x27
			1	frame	2,3	3,6	31x31x17
<i>Spokes</i>	1	sospensione	1	canopy	1,0	1,1	24x24x9
			1	structure	4,5	6,0	41x41x80
	2	sospensione	1	canopy	1,0	1,1	24x24x9
			1	structure	5,0	6,5	60x60x61
			1	canopy	1,0	1,1	24x24x9
2 large	sospensione	1	structure	6,0	7,5	80x80x83	
<i>Supernova</i>		sospensione	1		8,0	10,6	82x72x17
<i>Tartan</i>		sospensione	1	diffuser	4,0	6,5	49x49x44
			1	frame	0,7	0,8	19x19x14
<i>Tartan</i>	LED	sospensione	1	diffuser	4,0	6,5	49x49x44
			1	frame	1,9	3,0	17x17x35
<i>Tite</i>	1	sospensione	1	diffuser	0,8	2,0	123x29x30
			1	frame	0,6	1,2	80x16x14
	2	sospensione	1	diffuser	0,5	1,3	64x27x27
			1	frame	0,5	1,1	45x16x14
<i>Tivù</i>	grande	parete/soffitto	1		1,3	2,0	46x27x13
	piccola	parete	1		0,3	0,7	22x17x11
<i>Tress</i>	grande	parete	1	diffuser	0,4	1,6	68x32x19
			1	frame	0,7	0,9	36x12x9
			1	diffuser	1,1	2,9	51x51x44
		sospensione	1	frame	3,8	3,7	46x46x23
			1	diffuser	1,1	2,9	51x51x44
			1	frame	2,0	3,3	89x31x12
	grande LED	sospensione	1	diffuser	1,1	2,9	51x51x44
			1	frame	2,0	3,3	89x31x12
			1	frame+diffuser	5,0	8,5	200x30x34
		terra	1	base	5,5	6,0	26x26x3
			1	frame+diffuser	3,0	7,0	200x30x34
			1	base	5,5	6,0	26x26x3
	grande Halo	terra	1	frame+diffuser	3,0	7,0	200x30x34
			1	base	5,5	6,0	26x26x3
	media	sospensione	1	diffuser	1,6	3,5	118x30x30
			1	frame	0,8	1,0	21x21x15
		terra	1	diffuser	1,6	3,5	118x30x30
1			frame	2,3	2,5	28x28x15	
piccola	tavolo	1	diffuser	0,9	1,8	61x61x23	
		1	frame	2,3	2,5	28x28x15	
	parete	1	diffuser	0,3	1,5	48x32x19	
		1	frame	0,8	1,0	36x12x9	
	sospensione	1	diffuser	0,9	1,8	61x61x23	
		1	frame	0,8	1,0	21x21x15	
		1	diffuser	0,4	1,4	52x26x26	
mini	sospensione	1	frame	0,7	0,8	19x19x14	

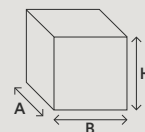
Packing

Model	Version	N° boxes	Description	net weight kg	gross weight kg	size cm A x B x H	
<i>Tress</i>	tavolo	1	diffuser	0,4	1,4	52x26x26	
		1	frame	1,0	2,0	21x21x15	
<i>Tress Stilo</i>	sospensione	1		0,5	1,2	76x12x12	
	terra	1	frame+diffuser	1,6	4,5	205x21x21	
		1	base	2,6	2,9	30x30x4	
<i>Troag</i>	<i>grande</i>	sospensione	1	3,5	6,0	227x16x15	
	<i>media</i>	sospensione	1	2,8	5,2	197x16x15	
	<i>piccola</i>	sospensione	1	1,8	3,9	137x16x15	
<i>Tropico</i>	<i>Ellipse</i>	sospensione	1	set elements	3,8	4,5	38x38x11
			1	set rings	1,3	2,6	72x72x6
			1	frame	1,0	2,7	52x26x26
			1	set of filters	0,5	0,3	48x6x6
	<i>Sphera</i>	sospensione	1	set elements	3,3	4,5	38x38x11
			1	set rings	1,7	2,5	63x63x6
			1	frame	1,0	3,3	73x26x26
			1	set of filters	0,5	0,3	48x6x6
	<i>Vertical</i>	sospensione	1	set elements	3,8	4,5	38x38x11
			1	set rings	2,9	3,5	33x33x15
		1	frame	1,0	5,2	161x26x26	
		1	set of filters	0,5	0,3	48x6x6	
<i>Tuareg</i>	terra	1	structure	2,8	4,2	87x87x106	
		1	base	6,4	8,8	157x24x17	
<i>Tutù</i>	parete	1	glass	0,5	1,2	37x18x24	
		1	frame	0,3	0,7	36x12x9	
<i>Twice as Twiggy</i>	sospensione	1	diffuser	5,4	8,4	85x85x56	
		1	canopy	2,9	3,3	25x25x14	
		1	diffuser	5,4	12,7	87x87x58	
	terra	1	stem	5,0	8,1	203x26x16	
		1	base	7,0	13,7	113x112x4	
		1	ballast	29,5	37,5	85x80x7	
		1	ballast base	24,4	29,0	109x109x10	
		1	assembling tool	3,0	4,4	38x18x103	
<i>Twiggy</i>	sospensione	1	diffuser	1,6	2,8	51x51x32	
		1	frame	0,8	1,1	56x16x17	
	lettura	1	diffuser	1,0	2,1	51x51x32	
		1	frame	1,5	3,0	164x21x22	
		1	base	8,3	8,7	55x55x6	
	soffitto	1	diffuser	1,6	2,8	51x51x32	
		1	frame	4,0	6,0	194x30x18	
	terra	1	diffuser	1,6	2,8	51x51x32	
		1	frame	1,5	3,9	187x21x23	
		1	base	13,5	15,3	69x69x7	
1		stem set	0,1	0,4	96x6x7		
1		diffuser	1,6	3,5	51x51x32		
<i>LED</i>	terra	1	frame	2,0	3,0	171x19x12	
		1	base	13,5	15,3	69x69x7	
		1	diffuser	1,1	1,5	69x22x23	
<i>Twiggy XL</i>	tavolo	1	diffuser	1,1	1,5	69x22x23	
		1	frame	1,1	1,5	68x21x22	
		1	base	4,7	5,5	45x45x6	
<i>Uto</i>		1		2,0	3,4	80x30x22	
<i>Yoko</i>	tavolo	1	diffuser	0,6	1,0	25x25x33	
		1	frame	1,4	2,1	38x21x21	
Accessories							
<i>Rosone multiplo</i>	<i>tondo</i>	1		9,0	10,7	61x61x9	
	<i>lineare 90</i>	1		6,8	7,7	100x27x9	
	<i>lineare 135</i>	1		10,0	11,5	145x27x9	

LED and dimming

Spare parts for lights with LED included.

LED modules can be replaced by qualified staff on-the-spot and the spare part can be purchased to the company for the following lights:

Allegro, Aplomb Large, Bahia – Bahia Mini, Big Bang – Big Bang L – Big Bang XL, Caboche grande – Caboche media, Chouchin – Chouchin reverse, Gem, Gregg Media, Lake, Le Soleil, Lightwing, Plass, Rituals XL, Satellight, Tartan, Tress grande, Tuareg, Twiggy, Twice as Twiggy.

Dimming

The following lights can be dimmed with On/Off – Push – DALI configurations:

Allegro, Aplomb Large, Bahia – Bahia Mini, Big Bang – Big Bang L – Big Bang XL, Buds LED included, Caboche grande – Caboche media, Chouchin – Chouchin reverse LED included, Dolmen, Gregg grande – Gregg media LED included, Innerlight, Jamaica, Le Soleil, Lumiere XXL/S LED included, Nuage, Rituals XL LED included, Spokes 1- Spokes 2 – Spokes 2 large, Tartan LED included, Tress grande, Troag, Twice as Twiggy.

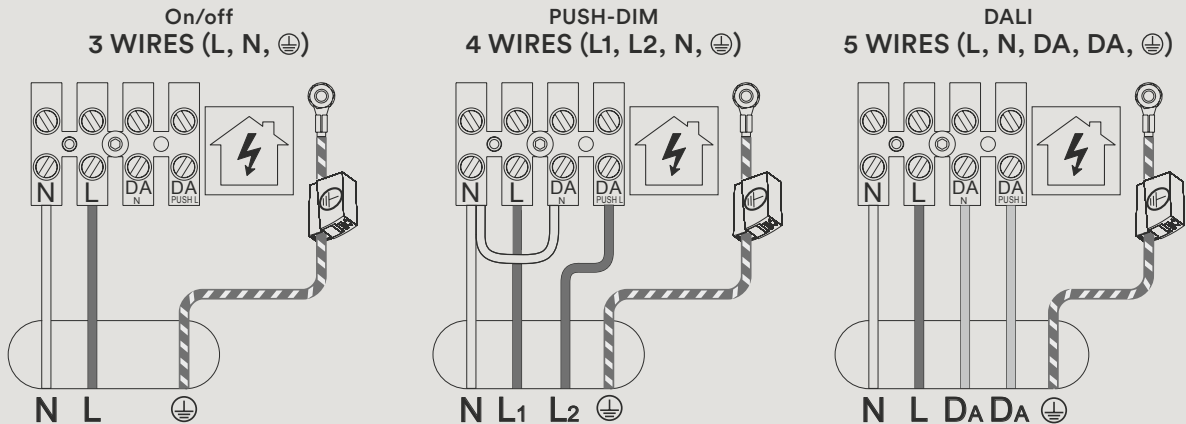

N = Neutro L = Linea DA = Dali PUSH = Dimmerabile Push

The following lights can be dimmed with TRIAC* or AD IGBT technology:

Arumi, Gregg Midi.

The LED retrofit bulb included for the following lights is dimmable with TRIAC* technology:

Buds – Chouchin – Gregg media – Rituals XL, Satellight.

* the minimum power output (Watt) adjustable by the recessed light dimmer has to be lower than the light or the LED retrofit bulb power.

Light Sources







According to the European norms, starting from 1st of September, the lighting fixtures equipped with bulbs that can be replaced by the final user have to be compatible with A+ bulbs (LED retrofit). The Foscarini lamps comply already with this requirement. Since a couple of years our price list states the possibility to use led retrofit bulbs besides the recommended halogen bulbs. If the fixture is supplied with a Pyrex glass, it has to be removed.











When using dimmable led retrofit bulbs, the correct dimming function is not granted. The actual state of the art of LED retrofit bulbs does not allow to obtain the same light flux as the halogen bulbs recommended by Foscarini. In order to give a more complete information, we remind you that the exit of halogen bulbs from the EU market has presently been postponed to September 1, 2018 for the E27 or E14 bulbs. Otherwise, for the R7s or G9 bulbs. It has been postponed to 2021.

This table contains the necessary information to purchase the correct light source (Foscarini models with integrated LED excluded).

The light tones may vary from one bulb to another. Foscarini recommends the use of warm light bulbs for its whole collection. The light bulbs available on the market may feature technical specifications with various graphics and definitions, but a warm light tone is generally described as: Warm White - 2700- 3000K° and CRI > 80.

* Expressed in mm

Model	Version	Type	Fitting Base	Lenght*	Width*	Notes
<i>Allegretto</i>	sospensione	Halo / LED retrofit	E27-PAR	max 85	Ø96	
<i>Allegro</i>	sospensione	Halo / LED retrofit	E27-PAR / R7s	max 99 (E27 PAR) 118 (R7s)	Ø96	
<i>Aplomb GU 10</i>	sospensione	LED retrofit	GU10-PAR	max 80	Ø80	
<i>Aplomb mini</i>	sospensione	LED retrofit	GU10-PAR	max 80	Ø80	
<i>Aplomb G9</i>	sospensione	Halo / LED retrofit	G9	max 60	max Ø18	
<i>Aplomb</i>	terra	Halo / LED retrofit	R7s	78	max Ø25	
<i>Bahia-Bahia mini</i>	soffitto/parete	Fluo	2GX13 T16-R	300/230	Ø16	
<i>Behive</i>	tavolo	Halo / LED retrofit dimm.	E27		max Ø65	
<i>Behive</i>	sospensione	LED retrofit / Fluo / Halo	E27		max Ø65	
<i>Big Bang</i>	sospensione	Halo / LED retrofit	R7s	118	max Ø29	
<i>Big Bang</i>	sospensione	Fluo	GX24q-3	130	//	
<i>Big Bang</i>	soffitto/parete	Halo / LED retrofit	R7s	78	max Ø25	
<i>Binic</i>	tavolo	LED retrofit / Fluo	E14	max 110	max Ø40	
<i>Birdie</i>	tavolo grande /terra /sosp gr.	LED retrofit / Fluo / Halo	E27	max 180	max Ø120	
<i>Birdie</i>	tav. piccolo /sosp./soff./par.	LED retrofit / Fluo / Halo	E27	max 110	max Ø80	
<i>Bit</i>	parete	LED retrofit / Fluo / Halo	E14	max 140	max Ø45	
<i>Blob</i>	soffitto/parete	Fluo	2G11	320	//	
<i>Buds</i>	tavolo / sospensione	LED retrofit / Fluo	E27	white globe Ø 120 for Buds 1-2 Ø 90 for Buds 3		
<i>Caboche</i>	sospensione piccola/tavolo	Halo / LED retrofit	G9	max 60	max Ø18	
<i>Caboche</i>	terra/sospensione/soffitto	Halo / LED retrofit	R7s	118	max Ø29	
<i>Caboche</i>	parete	Halo / LED retrofit	R7s	78	max Ø25	
<i>Caiigo</i>	sospensione	LED retrofit / Halo	GU10-PAR	max 62	max Ø51	
<i>Chouchin 1-2-3 & reverse</i>	sospensione	LED retrofit / Fluo / Halo	E27/E27 PAR	max 150	max Ø100	
<i>Chouchin mini</i>	sospensione	LED retrofit / Halo	GU10-PAR	max 60	max Ø55	
<i>Circus grande</i>	soffitto/parete	LED retrofit / Fluo / Halo	E27	max 100	max Ø70	
<i>Circus piccola</i>	soffitto/parete	LED retrofit / Fluo / Halo	E14	max 70	max Ø50	
<i>Doll</i>	tavolo	LED retrofit / Fluo	E14	max 110	max Ø60	
<i>Double</i>	parete	LED retrofit / Fluo / Halo	E27	max 110	max Ø60	
<i>Ellepi</i>	soffitto/parete	Fluo	2GX13 T16-R	300	Ø16	
<i>Esa grande</i>	tavolo	LED retrofit / Fluo / Halo	E14	max 130	max Ø66	
<i>Esa piccola</i>	tavolo	Halo / LED retrofit	G9	max 60	max Ø18	
<i>Fields 1-2-3</i>	parete	Fluo	G5	1449/1149/849	Ø16	
<i>Filo</i>	tavolo/lettura/parete	LED retrofit	G9	max 70	max Ø20	
<i>Folio grande piccola</i>	soffitto/parete	Halo / LED retrofit	R7s	78	max Ø25	
<i>Gem</i>	tavolo/sospensione	LED retrofit / Fluo / Halo	E27	max150	max Ø67	
<i>Giga-Lite</i>	terra/sospensione	LED retrofit dimmerabile / Fluo dimmerabile / Halo *	E27	max 150	max Ø80	
<i>Gregg grande</i>	tavolo/sospensione/terra	LED retrofit dimmerabile / Fluo dimmerabile / Halo *	E27	max 140	max Ø60	
<i>Gregg media</i>	tavolo/terra/sosp./soff./par.	LED retrofit dimmerabile / Fluo dimmerabile / Halo *	E27	max 140	max Ø60	
<i>Gregg piccola</i>	tavolo/sosp./soffitto/parete	Halo / LED retrofit	G9	max 60	max Ø18	

Model	Version	Type	Fitting Base	Lenght*	Width*	Notes
<i>Havana</i>	terra/sospensione/parete	LED retrofit dimmerabile / Fluo dimmerabile / Halo *	E27	max 125	max Ø60	
<i>Havana outdoor</i>	terra/sospensione	LED retrofit / Fluo / Halo	E27		max Ø60	
<i>Innerlight</i>	parete	Fluo	2G11	415	//	
<i>Kite</i>	parete	LED retrofit / Fluo / Halo	E14		max Ø50	
<i>Kurage</i>	tavolo	LED retrofit / Fluo	E27	max 135	max Ø65	
<i>Jamaica</i>	sospensione	Fluo	G5	1449	Ø16	
<i>Le Soleil</i>	sospensione	Halo / LED retrofit	E27/GU10 PAR	max 145 (E27)	max Ø80 (E27)	
<i>Le Soleil</i>	parete	Fluo	G24q-3	130	//	
<i>Lightweight</i>	sospensione	Halo	G4 12v			
<i>Lumiere grande piccola</i>	tavolo	Halo / LED retrofit	G9	max 60	max Ø20	
<i>Lumiere XXL XXS</i>	tavolo	Halo / LED retrofit	G9	max 60	max Ø20	
<i>Lumiere XXL</i>	soffitto/parete	Fluo	2GX13 T16-R	300	Ø16	
<i>Lumiere XXS</i>	soffitto/parete	Fluo	2G24q-2	140	//	
<i>Maki</i>	sospensione	LED retrofit / Halo	GU10-PAR		max Ø55	
<i>Mite</i>	terra	Halo / LED retrofit dimm.	E27	max 145	max Ø60	
<i>Nuage</i>	soffitto/parete	Fluo	2GX13 T16-R	300/230	Ø16	
<i>Orbital</i>	terra	Halo	E14	max 85	max Ø45	
<i>O-Space</i>	sospensione	Halo / LED retrofit	R7s	78	max Ø25	
<i>Planet</i>	sospensione	LED retrofit / Fluo / Halo	E27		max Ø180	
<i>Plass media</i>	tavolo	LED retrofit dimmerabile / Fluo dimmerabile / Halo *	E27		max Ø60	
<i>Plass media</i>	sospensione	LED retrofit / Fluo / Halo	E27		max Ø60	
<i>Plass grande</i>	sospensione	Halo	G9/GU10 PAR		max Ø60 (GU10 PAR)	
<i>Polygregg grande</i>	tavolo	LED retrofit / Fluo	E27		max Ø60	
<i>Gregg outdoor XL -grande</i>	tavolo/terra out./ sosp. out.	LED retrofit / Fluo	E27		max Ø60	
<i>Polygregg media</i>	tavolo	LED retrofit / Fluo	E27	max 140	max Ø60	
<i>Gregg outdoor media</i>	tavolo/terra out./sosp. out.	LED retrofit / Fluo	E27	max 140	max Ø60	
<i>Rituals 1-2-3 G9</i>	tavolo	Halo / LED retrofit	G9			
<i>Rituals 1-2-3</i>	tavolo/sosp./soffitto/parete	LED retrofit dimmerabile / Fluo dimmerabile / Halo *	E27	max 110	max Ø70	
<i>Rituals XL</i>	tavolo/sospensione	LED retrofit dimmerabile / Fluo dimmerabile / Halo *	E27	max 140	max Ø60	
<i>Satellight</i>	sospensione	LED retrofit dimmerabile / Fluo dimmerabile / Halo *	E27	max 145	max Ø80	
<i>Solar</i>	outdoor	LED retrofit / Fluo	E27	max 135	max Ø150	
<i>Supernova</i>	sospensione	LED retrofit / Fluo	E27	white globe max	Ø120	
<i>Tartan</i>	sospensione	LED retrofit / Fluo / Halo	E27		max Ø120	
<i>Tite</i>	sospensione	LED retrofit / Fluo / Halo	E27		max Ø150	
<i>Tivu grande</i>	soffitto/parete	Fluo	2G11	225	//	
<i>Tivu piccola</i>	parete	Halo / LED retrofit	G9	max 60	max Ø18	
<i>Tress stilo</i>	terra	Halo / LED retrofit dimm	E27-PAR	max 100	100	
<i>Tress grande</i>	sospensione	Halo / LED retrofit	R7s	118	max Ø150 (E27 PAR) max Ø23 (R7s)	
<i>Tress</i>	parete	Halo / LED retrofit	R7s	78	max Ø25	
<i>Tress media/piccola</i>	tavolo/terra/sospensione	LED retrofit dimmerabile / Fluo dimmerabile / Halo *	E27/E27 PAR		max Ø150	
<i>Tress grande</i>	terra	Halo / LED retrofit	R7s/E27 PAR	118 (R7s)	max Ø150 (E27 PAR)	
<i>Tress mini</i>	tavolo/sospensione	Halo / LED retrofit dimm	GU10-PAR		max Ø150	
<i>Troag 1-2-3</i>	sospensione	Fluo	G5	1449/1149/549	Ø16	
<i>Tropico Vertical</i>	sospensione	Fluo	2G11	535	//	
<i>Tropico Sphera /Elipse</i>	sospensione	Fluo	2G24q-4	155	//	
<i>Tutù</i>	parete	LED retrofit / Fluo / Halo	E14	max 85	max Ø40	
<i>Twiggy</i>	tav./ter./lettura/sosp./soffitto	LED retrofit dimmerabile / Fluo dimmerabile / Halo *	E27	max 130	max Ø75	
<i>Uto</i>	tavolo/sospensione/outdoor	LED retrofit / Fluo	E27	max 160	max Ø100	
<i>Yoko</i>	tavolo	LED retrofit / Fluo	E27	max 160	max Ø70	

Foscarini SpA

via delle Industrie 27
 30020 Marcon / Venezia / Italy
 T +39 041 595 3811
 F +39 041 595 3820
 foscarini@foscarini.com

Foscarini Inc

17 Greene Street, New York
 NY /10013 / USA
 T +1 212 247 2218
 F +1 646 545 2564
 foscarini.inc@foscarini.com

Foscarini Japan K.K.

Oak Minami-Azabu
 Building, 19-23,
 Minami-Azabu 3-chome,
 106-0047 Minato-ku
 Tokyo / Japan
 foscarini.jpn@foscarini.com

Foscarini Spazio Brera

via Fiori Chiari 28 /
 via Pontaccio 19
 20121 / Milano / Italy
 T +39 02 870 71320
 spaziobrera@foscarini.com

Foscarini Spazio Soho

17 Greene Street, New York
 NY /10013 / USA
 T +1 212 257 4412
 spaziosoho@foscarini.com

Azienda certificata

UNI EN ISO 9001

UNI EN ISO 14001

edition 11.2017

Concept and graphic design:
 Designwork
 art direction: Artemio Croatto
 art work: Erika Pittis / Designwork

Photography:

Massimo Gardone /Azimut

Printed in Italy

Grafiche GFP

foscarini.com

Follow us:



@foscarinilamps



FOSCARINI